

CapTel® 2400i

With Speakerphone



CapTel Acceptable Use Policy

The CapTel phone is intended for use by people with hearing loss. People who do not need captioning support should only use CapTel with the CAPTIONS feature turned off. Federal law prohibits anyone but registered users with hearing loss from using Internet Protocol (IP) Captioned Telephones with the captions turned on.

CapTel 2400i SP Specifications

Physical Dimensions

Size: 12.56" wide × 9.54" tall × 3.64" deep (Dimensions with the stand folded against the phone.)
Weight: 3 lbs. 2.3 oz.

Power

AC Adapter: 5.9-6.0V 3Amps
(barrel is negative)
Adapter is UL listed.

Dial Pad

Large keys: 0.62" × 0.56"

Display

10.1" Backlit, graphical LCD color display
1024 × 600 pixels
Resistive touch panel

Function Buttons

Volume
Speaker
Mute
Customer Service speed dial
Home
Captions

Controls

Conversation Amplification:
0–40dB gain
Tone: low, medium, high
Customizable to match personal audiogram

Model

CapTel 2400iSP-NBT

Indicator Lights

Mute
Volume Levels (1 through 12)
Captions on/off
Ring Flasher

Handset

Type: HAC (Hearing Aid Compatible)
Amplification: 40dB gain
TIA-4953 Approved

Dialing

Phone Book (100 entries)
Favorites (10 entries)
Speed Dial (4 entries)
Redial (Last number dialed)

Captions

Nine (9) Caption font sizes:
Small
1 – 0.20" (5 mm)
2 – 0.23" (6 mm)
3 – 0.25" (6.5 mm)
Medium
4 – 0.30" (7 mm)
5 – 0.33" (9 mm)
6 – 0.48" (10.5 mm)
Large
7 – 0.51" (12 mm)
8 – 0.54" (13.5 mm)
9 – 0.90" (22 mm)
Adjustable colors for captions font and background
Five (5) font style options

Connections

Telephone line: requires RJ11 connection (can be standard analog line, VOIP, DSL with filter, or fiber optic. Does not support digital PBX system unless analog port available).
Ethernet or WiFi wireless network
AC Power

Approvals

ACTA Product-Labeling Number:
US:D8KTE00BCAP2400
FCC ID: D8K-CAPTEL2400IS2
Contains FCC IDs:
YOPGS2101M, QOQWT12
FCC approved: Part 15B
REN = 0.0B
TIA-4953 Approved Handset

Conversation Memory

360,000 characters (minimum of 10 hours of conversation per call)

Caller ID History

Info saved for last 100 calls

Answering Machine

100 recordable messages
Default or personalized greeting
Selectable number of rings before answer
Max message length: 90 seconds

NOTE: Your CapTel phone will periodically connect to the Captioning Service through the Internet and/or phone line connection to report its status and check for software updates.

Congratulations on Choosing *CapTel*!

Welcome to the Captioned Telephone – CapTel! With CapTel, you can see captions of everything people say over the phone, letting you enjoy calls with confidence.

Your CapTel phone is easy to use. It works just like any other phone. You can dial on the number keypad and listen on the handset. Or, you can use the easy touch screen display to make and answer calls. Whatever works best for you.

If you ever have any questions, please refer to this guide to learn:

- How to start using your CapTel 2400i
- How your CapTel 2400i works
- How to get help when you have questions

As you use your new phone, we welcome your questions and comments. If we can help, please call.

Thank you for choosing the CapTel captioned telephone.





Sincerely,

CapTel Customer Service

1-888-269-7477

www.CapTel.com

T A B L E O F C O N T E N T S

	Overview – How CapTel Works	4
	Section 1: Getting Started	5
	What is in the box.....	5
	Overview of CapTel 2400i phone	6
	Setting up your CapTel 2400i	11
	Section 2: Making and Answering Calls	22
	Dialing a phone number directly	23
	Answering an incoming call.....	25
	Switching Captioning Method During a Call	26
	Turning captions on/off during a call	27
	Adjusting the volume	27
	Adjusting the Tone Control.....	28
	Customizing the Tone setting.....	29
	Using the Speakerphone	30
	Knowing what sounds are on the line	32
	Section 3: Viewing Captions	34
	Turning captions on/off during a call	35
	Viewing corrections.....	36
	Reviewing captions during a call.....	37
	Reviewing captions after hanging up.....	38
	Saving conversation captions.....	39
	Erasing captions.....	40
	Changing the color of the captions.....	41
	Changing the captions font size and style	43
	Setting how captions scroll across the Display Screen	44
	Adjusting the brightness of the Display Screen.....	45
	Section 4: Call History	46
	Reviewing previous calls	47
	Reviewing captions from a previous call	48
	Dialing from Call History.....	49
	Deleting previous calls	50



Section 5: Answering Machine 51

About the Answering Machine	52
Turning Answering Machine on/off	53
Playing your Answering Machine messages	54
Erasing Answering Machine messages	55
Deleting all messages	56
Recording a personal greeting	57
Remote Message Retrieval.....	59
Captioning messages from an external answering machine.....	62
Setting the ring count	63
Playing incoming messages aloud/silent.....	64
Seeing captions of your Voicemail messages	65



Section 6: Contacts 72

Adding a new contact	73
Dialing a phone number in your Contact List.....	74
Editing an existing contact	75
Removing a contact	76
Adding a contact to Speed Dial	77
Adding a photo to a contact	78



Section 7: Favorites 90

About Favorites.....	91
Adding a contact to Favorites.....	92
Dialing Favorites	93
Removing a contact from Favorites.....	93



Section 8: Settings 94

Setting the language	95	Saving conversation volume... ..	100
Switching captions language....	96	Keypad lights	100
Setting Default Language	97	Setting the ringer volume.....	100
Setting Display Brightness.....	98	Adjusting the ringer pitch.....	100
Screen timeout.....	98	Tone control	101
Night mode	98	Time Zone	101
Network	98	About your CapTel phone	101
Saving captions after hang up.....	99	Updating your software.....	101
Captions button.....	99	Advanced settings	102
Ring flasher.....	99		



Troubleshooting 104

Index 105

How CapTel Works



Your new CapTel 2400i works like any other phone – just pick up the handset and dial the person you want to call on the dialing keypad. Every time you make a call, the phone also connects over the Internet to a Captioning Service. The Captioning Service uses speech recognition technology (either automated or operator-assisted) to create captions of everything your caller says. The captions appear on your CapTel 2400i display screen for you to read.

You can enjoy conversations over the phone, with the added help of written captions.

NOTE *The CapTel 2400i phone does not generate captions of the phone call on its own. The phone works with the Captioning Service (over the Internet connection) to display captions during your calls.*

Getting Started

This section explains how to start using your new CapTel 2400i phone.

TOPICS

- **What is in the Box**
- **Overview of CapTel 2400i**
- **Setting up Your CapTel 2400i**

What is in the Box?

Your CapTel 2400i includes the following parts:



- CapTel 2400i SP Phone
- Telephone Cord



- Power Adapter – to plug into a wall outlet



Important! Use only the power adapter that came in the box with your CapTel 2400i

- Ethernet Cable – to connect to Internet service *(not necessary for WiFi installations)*



- CapTel Setup Guide and CapTel User Manual



Overview of CapTel 2400i Phone



Please see the descriptions that correspond with the matching numbers on the next few pages to help explain what each feature is.



1 Touch Screen Display

Shows captions, Caller ID, Answering Machine messages, Contacts, and more. You can touch an item on the Display Screen to select it.



2 Time & Date



3 Ring Flasher

Bright lights blink to alert you to any incoming calls and new answering machine messages.



4 Settings

Lets you control and adjust the features of your phone.



5 Contacts

Allows you to store and quickly dial people you call often. Saves up to 100 contacts.



6 Favorites

Saves the phone number of people you call most often for quick and easy dialing.



7 Call History

Shows your most recent incoming and outgoing calls, plus lets you read captions from previous phone calls.



8 Answering Machine

Turns the Answering Machine on/off and lets you check messages – with captions.



9 Volume Button

Lets you adjust the volume to a comfortable level, up to a 40dB gain from min/max. To increase the volume, press plus sign **+** on the VOL button. Press minus sign **-** on the VOL button to decrease the volume. The indicator lights next to the volume bar indicate the volume setting.

WARNING

The maximum volume setting is extremely loud. People who do not need amplification should not use the phone at the highest volume level.

The volume returns to a mid-range setting every time you hang up the handset. To save your volume setting so that it will be used during every call, see “Saving Conversation Volume” on page 100.

- ## 10 Built-in Microphone

Speak near to the microphone when using the speakerphone.



11 SPEAKER Button

Lets you talk/listen over the built in speaker, to enjoy hands-free conversations.



12 Dialing Keypad

Use to dial telephone numbers – just like with any other phone.



13 HOME Button

Press the HOME button at any time to return to the main menu screen. The HOME button is your easy way to go back to the beginning and start again.

NOTE

If you are ever “lost” in the menu system, press the HOME button to return to the main screen.



14 **CAPTIONS Button**

When the CAPTIONS button is on (blue light around button is lit) you will see word-for-word captions of everything the other party says. Press the CAPTIONS button at any time during a call to turn captions on or off.



15 **MUTE Button**

Silences the sound from your end of the conversation. When the MUTE button is pressed (red light around the button is ON), the person on the other end of your call will not be able to hear you. You will still be able to hear the caller and get captions of everything they say. To turn the Mute feature off, press the MUTE button again (light around the button is OFF).



16 **CUSTOMER SERVICE Button**

Pressing the CUSTOMER SERVICE button will automatically dial the CapTel help line. Our helpful Customer Service team is happy to help you set up and use your CapTel 2400i phone – we're only a button push away.

NOTE

*Help is available 24 hours a day, 7 days a week (closed on major holidays).
Help materials are also available online at www.CapTel.com*

Back view of CapTel 2400i



1 Telephone Jack

Plug the telephone cord (provided) in here (RJ11 jack). Telephone cord can be for most types of telephone service, including: analog, VOIP, fiber optic, digital cable service, or analog with DSL service. CapTel does NOT work with PBX systems unless an analog port is available.

2 LNK/ACT – Status Light

Lets you know if your Ethernet cable is connected to the Internet and whether activity is on the line. NOTE: the LNK/ACT indicator does not light up when connected via WiFi.

3 Ethernet Jack

Plug the Ethernet cable (provided) here to connect to your Internet service. If you connect to the Internet using a WiFi network, you do not need to plug in the Ethernet cable.

4 Power Jack

Plug the AC power adapter here. Use only the AC power adapter that came with your CapTel 2400i phone. Any other adapter may damage the phone.

5 Kickstand

Pull out and position the kickstand to find the most convenient angle for reading the CapTel display screen.

Setting up Your CapTel 2400i

For complete instructions, please see the Setup Guide.

Requirements

- 1. High-speed Internet access.** Your CapTel 2400i can connect to your Internet service either with an Ethernet cable or through a wireless (WiFi) network. Depending on your Internet setup, a router may also be required to allow you to connect more than one device to your Internet service.
- 2. Telephone Service.** Can be analog line, DSL with filter, VOIP, fiber optic, or Digital Cable phone service. CapTel does NOT work with digital Private Branch Exchange (PBX) systems found in some office environments, residential facilities, and hotels – unless an analog port is available.

NOTE

If you do not have dial-tone telephone service, contact Customer Service for installation assistance with Internet-only option.

- 3. Standard electrical power** (AC adapter plugs into standard wall outlet).

Step 1: Select a Location

Pull out the kickstand in the back, then set up the CapTel 2400i in a place where:

- A high-speed Internet (Ethernet) jack or your wireless router is located nearby.
- A telephone jack is located nearby (can be analog line, DSL with filter, VOIP, fiber optic, or Digital Cable phone service).
- There is an electrical outlet nearby.
- The surface it will be set on is stable and secure.
- The area is protected from excessive heat or humidity.

NOTE

The outlets for power, the phone line, and the Ethernet connection should all be located nearby, as each cord needs to plug into your CapTel 2400i. If your Internet access is located in a different room than where you plan to use the CapTel 2400i, a WiFi setup is recommended. Please see the Setup Guide or contact CapTel Customer Service for help setting up.

Step 2: Plug in the Power Adapter

1. Plug the power cord into the jack labeled "Power" on the back of the CapTel 2400i phone.
2. Plug the power adapter into a wall outlet or power strip. The display screen and Volume indicator lights will light up to let you know the power is connected.

WARNING:

Be sure to use only the power adapter that came with your CapTel 2400i. Using any other power adapter may damage your phone.

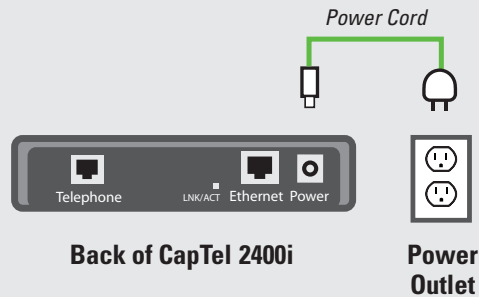



After a moment, the Initial Setup screen will appear. Follow the instructions on the display screen.

TIP To choose an option, touch the icon on the screen and then touch  (**next**).

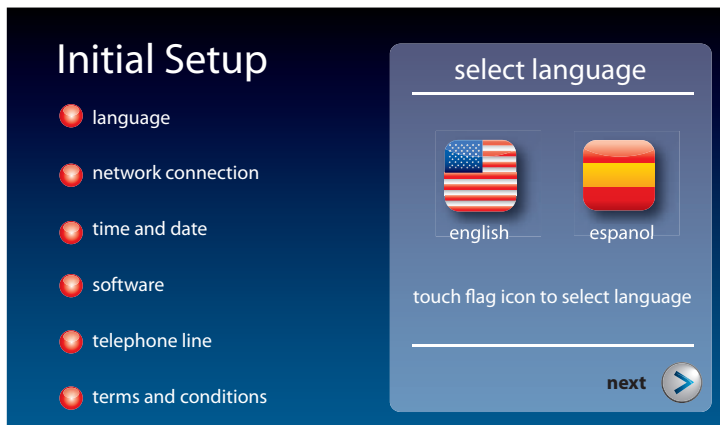
Step 3: Select Language



1. Touch  (**English**) or  (**Espanol**) for the language you want.
2. Touch  (**next**) to continue.

Step 4: Network Connection

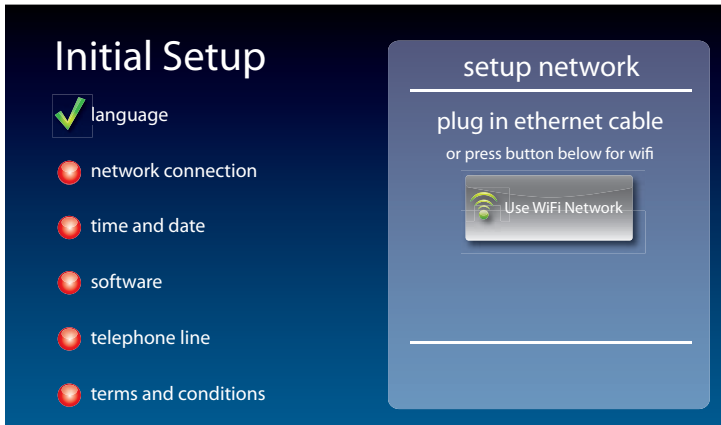

For Wired Connections:

1. Plug the Ethernet cable that came with your phone into the jack on the back labeled "Ethernet".
2. Plug the other end of the Ethernet cable into the jack you use to access your Internet service. Depending on how your Internet service is set up, you could be plugging into an available Ethernet jack on any of the following:
 - On a digital cable modem
 - On a DSL modem
 - On a router in your home
 - In an Ethernet wall outlet

Use the examples on the following page to match your setting with the correct installation method.

All outlets located together (Wired Setup)

Example 1: All of the connection outlets (telephone, Internet, and power) are available in the same room that you are planning to use the CapTel 2400i.

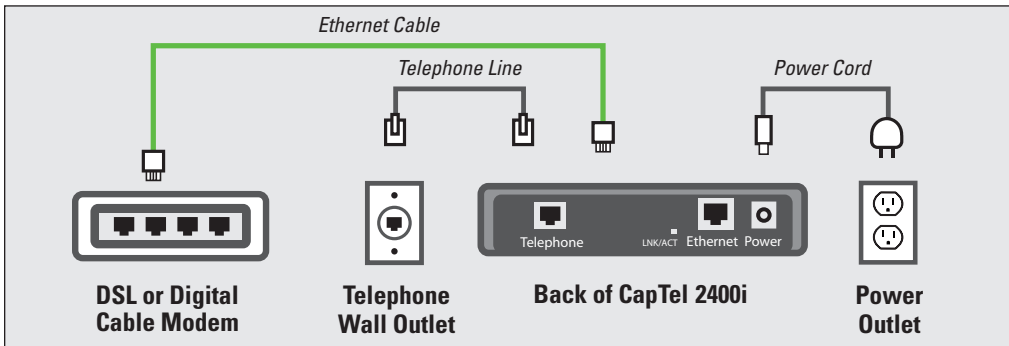

Example 2: If there is not an available Ethernet jack in your DSL or cable modem, you will need a router or switch that lets you connect more than one device to the Internet. Contact your Internet Service Provider to learn what router or switch will work with your modem. The router should support DHCP. Connect the router to your DSL/cable modem. Then connect the CapTel 2400i to the router or switch using the Ethernet cable.

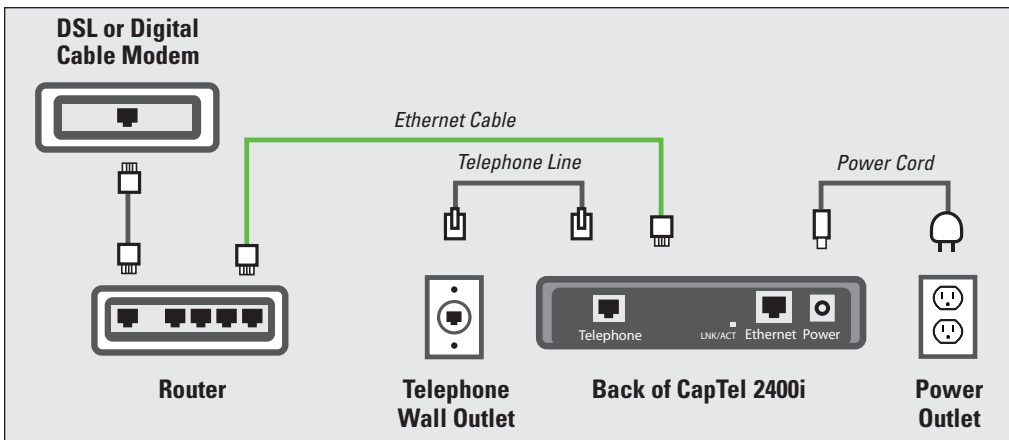

NOTE If your Internet outlet is in a different room from where you plan to use CapTel, see the Setup Guide for instructions.

For Wireless (WiFi) Connections:

If you have a wireless (“WiFi”) network in your home or office, your CapTel phone can connect to the Internet using the WiFi network. You do not need to plug in an Ethernet cable.

To set up your CapTel for WiFi use, you will need to know the name of your wireless network as well as any passwords that are needed to access the network. The way you access your WiFi network with CapTel will be very similar to how you access the network from a computer or mobile device.

NOTE

If someone helped install the wireless network for you, it may be helpful to consult with that person as you set up your CapTel phone.

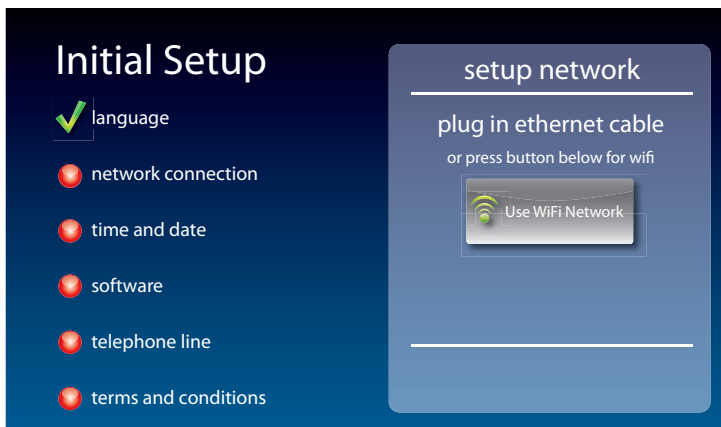

1. Touch  **(Use WiFi Network)** on the display screen. CapTel scans for wireless networks within range of your phone.
2. The display lists any WiFi networks detected, in order of strongest signal strength to the weakest signal strength.

NOTE

CapTel may detect wireless networks in your location that you do not recognize – such as a wireless network from a neighbor or nearby office. Be sure to select the name that matches your own network.



3. Touch the name of the network that you want to use.

Then touch **(Connect)**.

If you do not see the network you want to use:

- Try moving your CapTel phone to an area closer to your wireless router. Then, touch **(Refresh)**. CapTel will re-scan for available networks.
- Touch **(Enter Manually)**. CapTel will ask you to enter information about your wireless network, then it will try to connect.

4. **Enter WiFi Password:** On the display, use the onscreen keyboard to enter the password for your WiFi network.



TIP Remember to use the **(shift)** key for capital letters when needed. Passwords are case-sensitive. To enter special characters, touch **(Numbers)**.

When you are done, review your password carefully. If it does not exactly match the password for your network, CapTel will not be able to connect. Use the  key to correct any errors.

When you are satisfied the password is correct, touch  **(save)**.

Step 5: Time and Date

Touch the Time Zone on the display screen that you live in. Be sure to indicate if your Time Zone practices Daylight Savings Time (DST). Touch  **(next)** to continue.

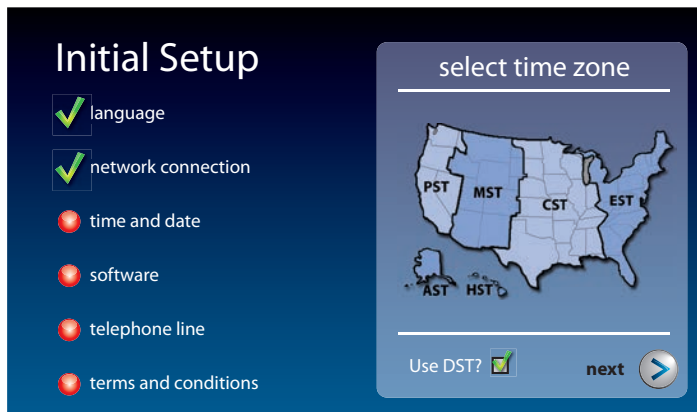

Your CapTel phone will fill in the date and time based on the time zone you indicate.

Step 6: Software

Your new phone checks to make sure that you have the most current software available. If needed, CapTel will automatically download the most recent software version. Please be patient, the download may take a few moments. Watch the progress on the CapTel display screen to know the status.

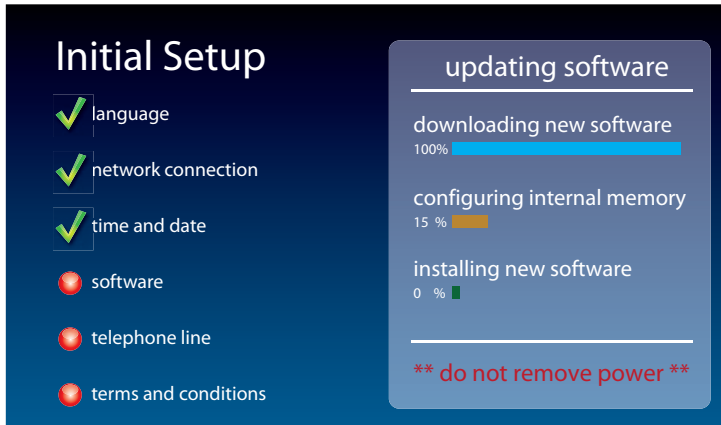

NOTE *Do not interrupt the power supply during a software download. It may damage your CapTel phone.*

Once the software download is complete, your CapTel phone will re-boot as part of the update process. It will automatically run through the setup steps again, using the settings that you've already chosen.

Once the update process is completed, you will be able to continue with setup.

Step 7: Telephone Line

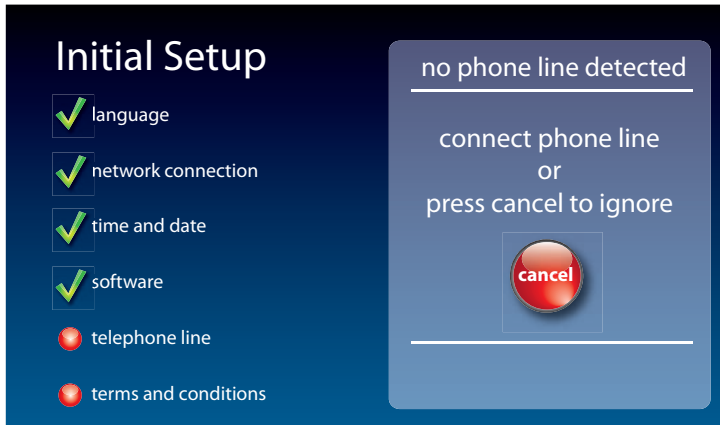

1. Plug your telephone line into the back of the CapTel phone.
2. Plug the other end of the line into your telephone wall jack.

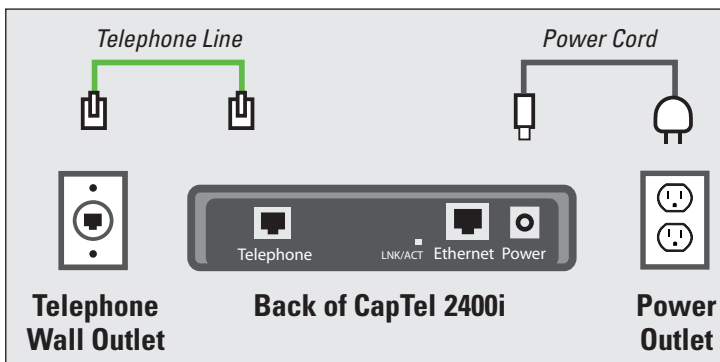

NOTE

Telephone service can be analog, VOIP, fiber optic, digital cable phone service, or analog with DSL filter. CapTel does not work with digital PBX office phone systems unless an analog port is available.

NOTE

If you do not have dial-tone telephone service, contact Customer Service for installation assistance with Internet-only option.

Step 8: Registration Terms and Conditions

The very first time you set up CapTel, you may be asked to review the Registration Terms and Conditions on the CapTel display. Follow the directions on the screen.

NOTE *If your CapTel 2400i is already registered, your phone will not show the following registration screen.*

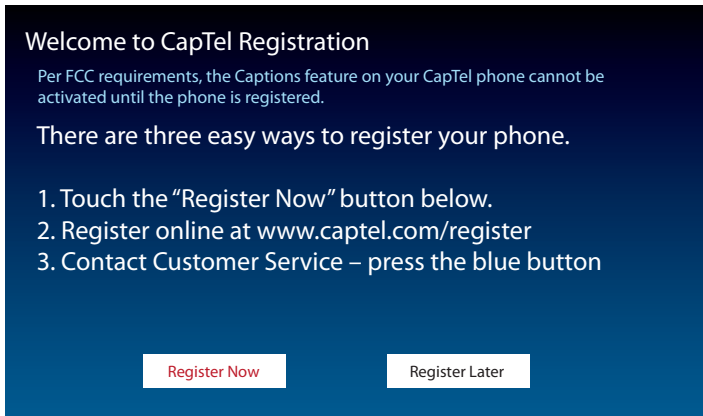

NOTE *Per requirements from the Federal Communications Commission (FCC), the Captions feature on your phone will not be activated until you accept the Registration Terms & Conditions. If you need assistance, press the blue **CUSTOMER SERVICE** button for help. Details about the FCC requirements can be found at www.CapTel.com.*

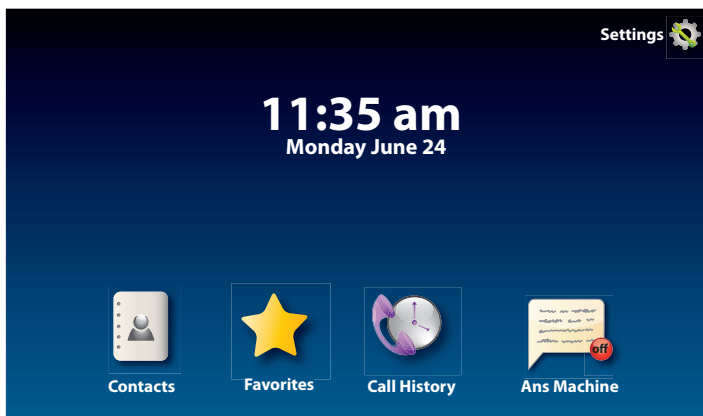

Step 9: Choosing your Captioning Preference

Your CapTel phone lets you select which captioning method to use, either fully-automated Auto Captions or enhanced Assisted Captions.

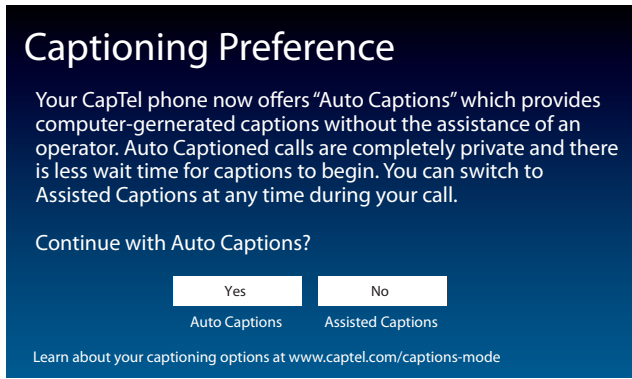

With **Auto-Captions**: Calls are entirely computer-generated.

- No operator on the call.
- Calls start almost immediately, no need to wait for an operator.
- Captions appear in real-time with no delays.

With **Assisted Captions**: An operator facilitates captioning, making corrections and providing call details.

- Operator makes corrections if needed.
- Captions include call details, such as background sounds, whether the speaker has (F) or (M) voice, music on hold, and the “beep” when you leave a voicemail message.
- If the line connection is poor or if there is static on the line, switching to Assisted Captions may improve accuracy.

Touch YES to use Auto Captions, or touch NO to use Assisted Captions.

Calls will start in whichever method you select. However, during a call, you can easily switch captioning methods—from Auto Captions to Assisted Captions—by following the onscreen instructions.

NOTE

911 Calls are given priority and will be processed using Assisted Captions once an operator is available. CapTel may adjust the captioning method of any call under certain circumstances, to provide the best possible captioning experience.

Making and Answering Calls



This section explains how to place outgoing calls and how to answer incoming calls.



TOPICS

- **Dialing a Phone Number Directly**
- **Answering an Incoming Call**
- **Turning Captions On/Off during a Call**
- **Adjusting the Volume**
- **Adjusting the Tone Control**
- **Customizing the Tone Setting**
- **Using the Speakerphone**
- **Knowing What Sounds are on the Line**

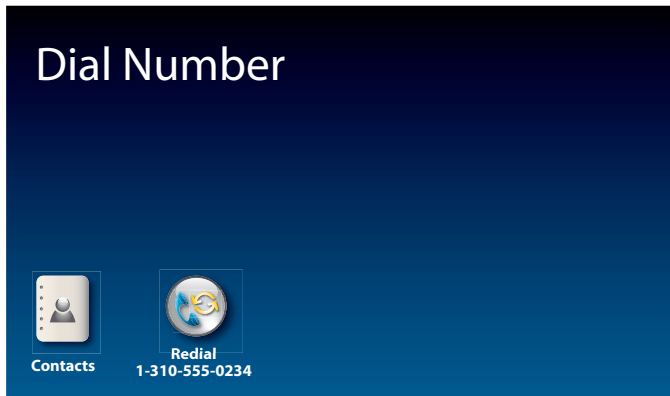
Dialing a Phone Number Directly



Like with any other phone, you can dial the phone number of the person you want to call.

1. Before you dial, check that the blue light around the  (**CAPTIONS button**) is on. If not, press the CAPTIONS button to turn captions on.
2. Lift the handset. Or, to make a call using the speakerphone, press  (**SPEAKER button**).
3. Use the CapTel dialing keypad  to dial the phone number of the person you wish to call.
4. As you dial, the display screen shows the status as your CapTel phone connects to the captioning service.

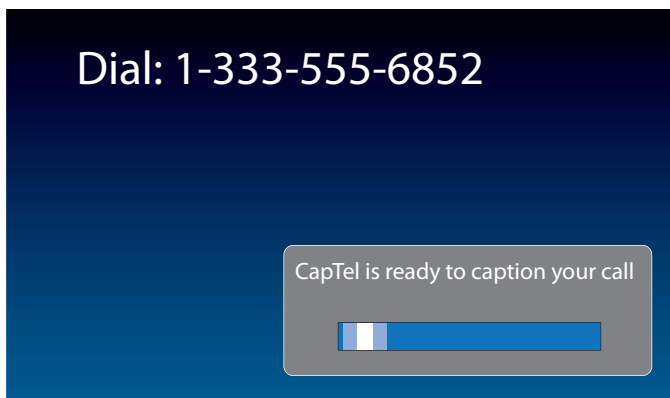

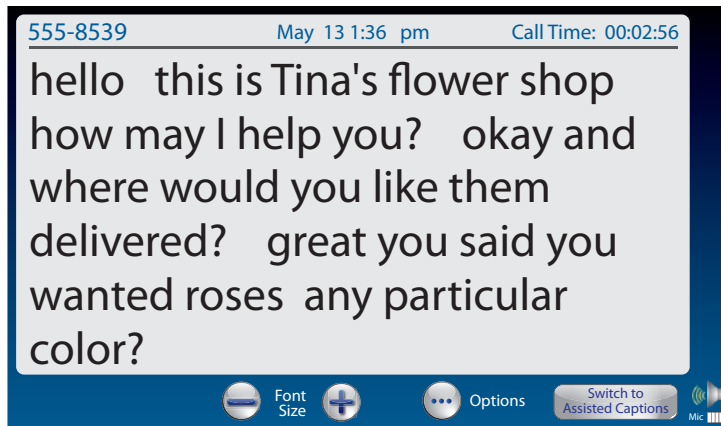

5. Listen or watch the display screen to know when someone answers. Begin your conversation as you normally would. Captions will appear on the display screen as the other party speaks.

You can adjust the volume during the call to a level you hear best by pressing **+** (plus) or **-** (minus) on the **VOL button**.

When you are finished with your call, hang up the handset.

TIP *You can turn captions on/off at any point in the call. Just press the CAPTIONS button. When the blue light is on, you will get captions.*



TIP *Talk back and forth as you normally would, reading the captions as you go. You don't need to wait for the captions to finish appearing on screen before you answer.*

NOTE *You can also place a call to someone listed in your Contacts, Favorites, Call History, or Speed Dial settings. You need to have entries saved in Contacts before you can use these features. See Contacts on page 72 for instructions.*

TIP *When you place a call, CapTel can automatically redial the last number dialed. When you lift the handset, simply touch the "Redial" icon on the screen. CapTel will dial the number automatically.*

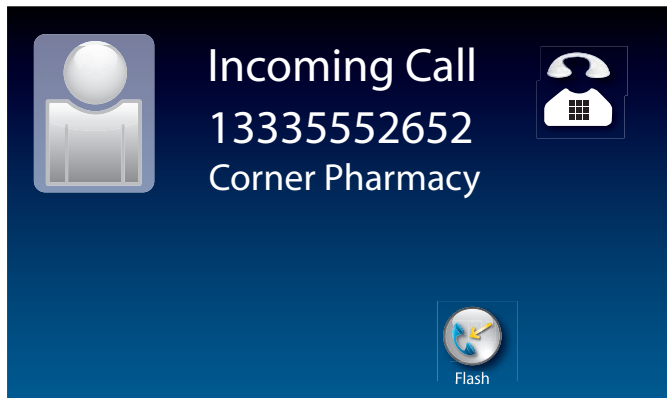
Answering an Incoming Call



1. When the phone rings, the display lights up to let you know there is an incoming call. (If you have Caller ID service, the caller's name and phone number will appear.)
2. Lift up the handset to answer the call. Or, to answer on speakerphone, press  (**SPEAKER button**).
3. Check that the blue light around the  (**CAPTIONS button**) is on. If not, press the CAPTIONS button to turn captions on.

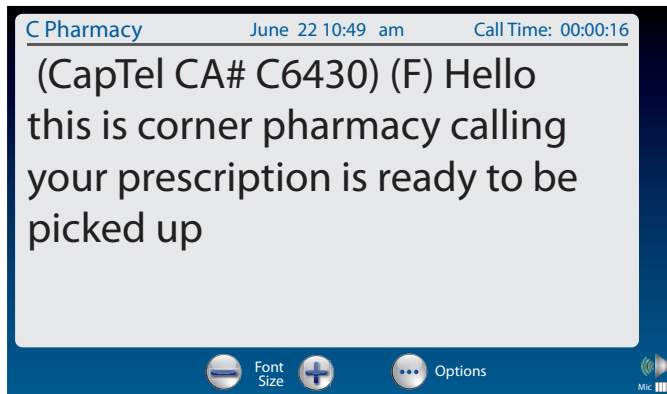

When you are finished with your conversation, hang up the phone as you normally would.

TIP *If you answer on an extension telephone and want to get captions, just pick up the CapTel handset. As long as the CAPTIONS button is on, your CapTel phone will connect to the Captioning Service and you will see captions. For details see Line in Use on page 103.*

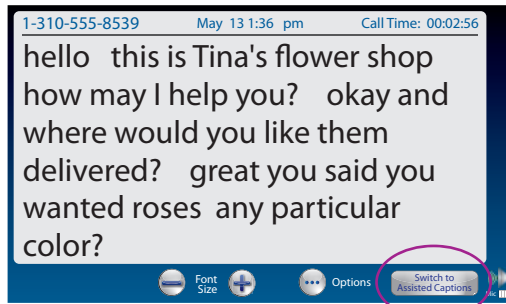

Switching Captioning Method During a Call



CapTel provides captions in two ways: either by fully-automated Auto Captions or by operator Assisted Captions. Calls start in whatever method you selected during setup. For more information, see *Choosing Your Captioning Preference* on page 21.

If your calls start in Auto Captions, you can switch captioning methods during a call to Assisted Captions. For example, if the telephone connection is poor or there is static on the line, switching to Assisted Captions may help improve accuracy. Assisted Captions also provides enhanced call information, such as any background sounds, indicating whether the caller's voice is male or female, and sounds on the line like the "beep" of a voicemail system.

To switch Captioning Methods during a call:

1. During a call, touch  (**Switch to CA**) at the bottom of the display screen. If you do not see , your call is already in Assisted Captions.
2. An operator (Captioning Assistant or CA) will come onto the line to help facilitate captions for the remainder of your call. The screen indicates that Assisted Captions is on.

NOTE *If a CA is not immediately available, CapTel will continue captioning your call in Auto Captions until a CA can join the call.*

3. Once you hang up at the end of the call, the next call you make or receive will start in Auto Captions again.

NOTE *To change your Captioning Preference default setting, please press the blue button to contact CapTel Customer Service for assistance.*

Turning Captions On/Off During a Call



You can turn captions on/off at any time during your call by pressing  (**CAPTIONS button**). When the blue light around the CAPTIONS button is lit, you will see captions of everything the other party says.

To turn captions off, press  (**CAPTIONS button**) again. The blue light around the CAPTIONS button goes off.

NOTE: Federal law prohibits anyone but registered users with hearing loss from using Internet Protocol (IP) Captioned Telephones with the captions turned on.

Adjusting the Volume

You can increase the volume of the person's voice coming through the handset or speakerphone, up to a 40dB gain from min/max. Watch the lights next to the VOL bar to see what level the volume is set to.

- To increase the volume, press  on the **VOL button**.
- To decrease the volume, press  on the **VOL button**.

NOTE

The maximum volume setting is very loud. People who do not need amplification should not use the phone at its highest volume setting. The volume level automatically returns to a mid-range setting whenever the phone is hung up.

To save your volume setting so that it will be used during every call, see "Saving Conversation Volume" on page 100.

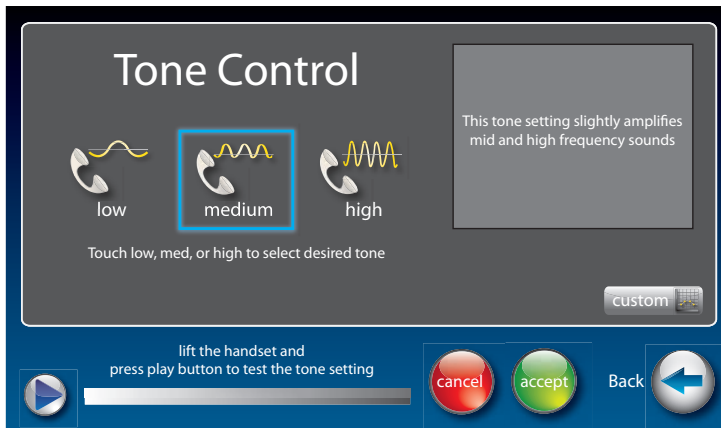

Adjusting the Tone Control





You can adjust the Tone of the handset sound to a frequency range that is better to hear. Use the Tone setting to emphasize HIGH, MEDIUM, or LOW frequency sound ranges. You can even customize the sound frequency to match your own audiogram. The setting will remain in effect until you change it again.

You can adjust the Tone setting before, during, or after a call.

To adjust the Tone setting:

1. On the display screen, touch  (**Settings**).
2. Touch  (**Sounds**).
3. Touch  (**Tone**).
4. The display shows what the current setting is: LOW, MED, HIGH, or CUSTOM.
5. Touch the Tone setting you wish to use.

TIP *To test how the Tone setting will sound, lift the handset and press  on the display screen. You will hear a recording of first a man's and then a woman's voice, letting you check if the setting makes it easier to hear. Experiment with the different Tone settings to find the range that works best.*

NOTE *During a call: touch  (**Options**) to adjust to a different Tone setting that you hear best.*

Customizing the Tone Setting

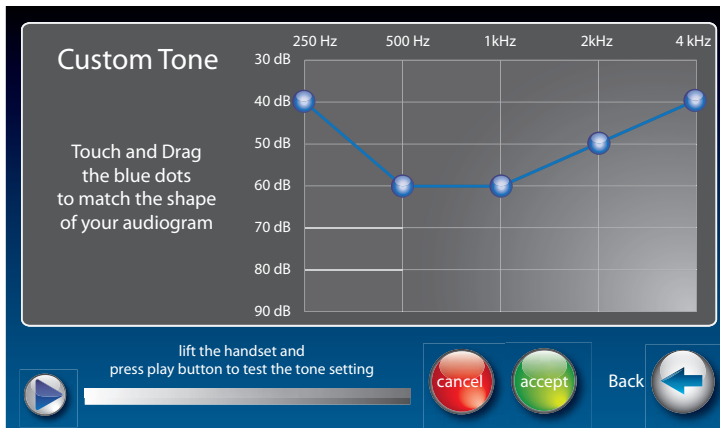

Your CapTel phone lets you personalize the Tone setting to enhance the frequency ranges that you hear best. For example, you can adjust the tone settings to match your own personal audiogram. CapTel lets you listen to test each setting as you make changes, to find the optimal customized hearing level.

To customize the Tone setting:

1. On the display screen, touch (**Settings**).
2. Touch (**Sounds**).
3. Touch (**Tone**).
4. On the display screen, touch (**Custom**).
5. Touch and drag the blue circles on the frequency chart to adjust the various sound levels.

As you make changes, test the sound quality by touching (**play**) while listening over the handset.

TIP *If you have a personal audiogram, adjust the blue circles to match the shape of your audiogram to give you optimal sound levels for your personal hearing level.*

6. When you are finished, hang up the handset and touch (**Accept**) to save your changes or (**Cancel**) to exit.

Using the Speakerphone

Turning the Speakerphone On

At any point before or during a call, press the  (**SPEAKER button**) on the CapTel dialing pad to turn the speakerphone on (light on SPEAKER button goes ON). The CapTel handset will turn off, and any sounds on the line will be amplified out loud over the CapTel speaker.

TIP *When the speakerphone is on, you can talk as you normally would directly facing the front your CapTel phone. You do not need to speak into the CapTel handset. The CapTel microphone will pick up your speech for your caller to hear.*

When the speakerphone is on you can set down or hang up the CapTel handset without ending the call. The conversation will be carried on over the speakerphone and captions of your call will appear on the display screen.

Turning the Speakerphone Off

You can alternate between using the speakerphone or using the CapTel handset during your calls, by turning the speakerphone on and off. The way you turn the speakerphone off depends on whether the CapTel handset is hung up or not.

If the CapTel handset is not hung up:

Press the  (**SPEAKER button**) on the CapTel dialing pad to turn the speakerphone off. The light on the speakerphone button will go off and the sound will be directed to the CapTel handset for you to continue the call.

If the CapTel handset is hung up and you'd like to continue the call:

Lift the CapTel handset. The speakerphone will go off and the sound will be directed to the CapTel handset for you to continue the call.

If the CapTel handset is hung up and you'd like to end the call:

Press the  (**SPEAKER button**) on the CapTel dialing pad. The speakerphone will go off and the call will end.

Ending a Call when the Speakerphone is On

The way to end a call when the speakerphone is on depends on whether the CapTel handset is hung up or not.

If the CapTel handset is hung up:

Press the  (**SPEAKER button**) on the CapTel dialing pad. The speakerphone will turn off and the call will end.

If the CapTel handset is not hung up:

Hang up the handset, as you would end with any other call. If needed, press the  (**SPEAKER button**) to turn the speakerphone off. The speakerphone will turn off and the call will end.

Adjusting the Sound on the Speakerphone

Use the volume key to adjust the volume of the sound coming out of the speakerphone.

Knowing What Sounds are on the Line

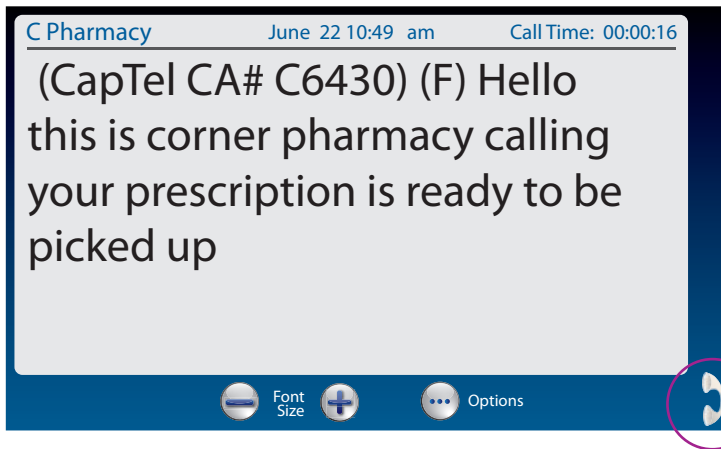

The handset graphic on the display screen tells you what incoming and outgoing sounds are occurring during your call with two visual indicators: the Signal meter (yellow waves) and the Outgoing Volume meter (blue waves).



Signal Meter – Sounds on the Line



Shows when there is sound coming over the line, even if the sound is not loud enough for you to hear. The more sound waves coming out of the handset, the louder the sound.



Outgoing Volume Meter

Helps you to see how loudly you are speaking. The more lines going into the handset/MIC graphic, the louder your voice is. If the lines become red, you may want to lower the volume of your own voice during a call.

TIP



The display shows whether sound is coming over the CapTel headset  or over the speakerphone .

NOTE

These meters only appear during calls that have captions.

Getting Help

If you have any questions as you use your new CapTel 2400i, we're here to help. Use any of these ways to contact us:

Pick up the handset and press  (**CUSTOMER SERVICE button**) to automatically speed dial directly to our helpful Customer Service team. If you are in an office setting, you may need to dial a number such as "9" first to get an outside line first and then press  (**CUSTOMER SERVICE button**). *(Available 24 hours a day, 7 days a week. Customer Service is closed on major holidays.)*

Help materials are also available online at our website.



Phone: 1-888-269-7477 *(Available 24 hours a day, 7 days a week)*

FAX: (608) 204-6167



Mail: CapTel Customer Service
450 Science Drive
Madison, WI 53711



Email: CapTel@CapTel.com

Online: www.CapTel.com
(Live Chat help available at our website)

Spanish Language Customer Service: 1-866-670-9134

Viewing Captions





This section explains how to adjust and review conversation captions.

TOPICS

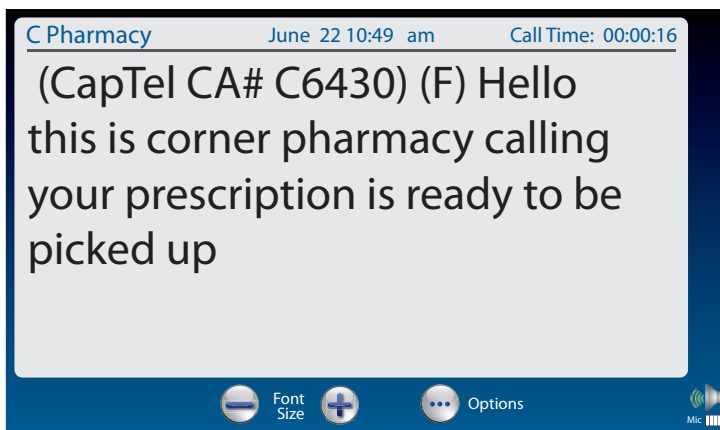

- **Turning Captions On/Off During a Call**
- **Viewing Corrections**
- **Reviewing Captions During a Call**
- **Reviewing Captions After Hanging Up**
- **Saving Conversation Captions**
- **Erasing Captions**
- **Changing the Color of the Captions**
- **Changing the Captions Font Size and Style**
- **Setting how Captions Scroll Across the Display Screen**
- **Adjusting the Brightness of the Display Screen**

Turning Captions On/Off During a Call



You can turn captions on/off at any time during your call by pressing  (**CAPTIONS button**). When the blue light around the CAPTIONS button is lit, you will see captions of everything the other party says.

To turn captions off, press  (**CAPTIONS button**). The blue light around the CAPTIONS button goes off.

NOTE You can increase/decrease the size of the captions font by touching  or  at the bottom of the screen.

TIP You can press the CAPTIONS button at any time during the call. If captions are not on at the start of your call, don't worry. Captions will appear shortly after the CAPTIONS button is turned on.

NOTE: Federal law prohibits anyone but registered users with hearing loss from using Internet Protocol (IP) Captioned Telephones with the captions turned on.

Viewing Corrections

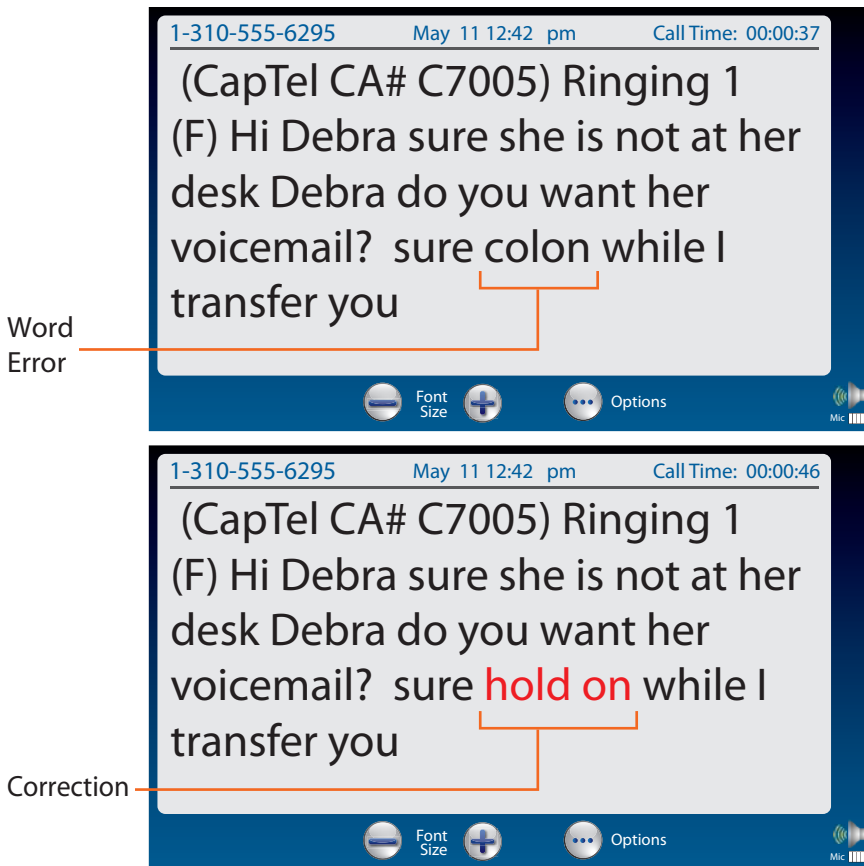

On occasion, word errors may appear in the captions due to the speech recognition system the Captioning Service uses. The Captioning Service will try to correct word errors as they occur. The corrected word appears in a different color than the rest of the captions to let you know a correction has been made.

There may be a slight delay before the word error is corrected. If you are unclear about what was said, ask your caller to clarify.

You can select which color you'd like the corrected word(s) to appear in. Please see "Changing the Color of the Captions" on page 41.

NOTE Corrections only appear when you are in Assisted Captions mode.

Reviewing Captions During a Call

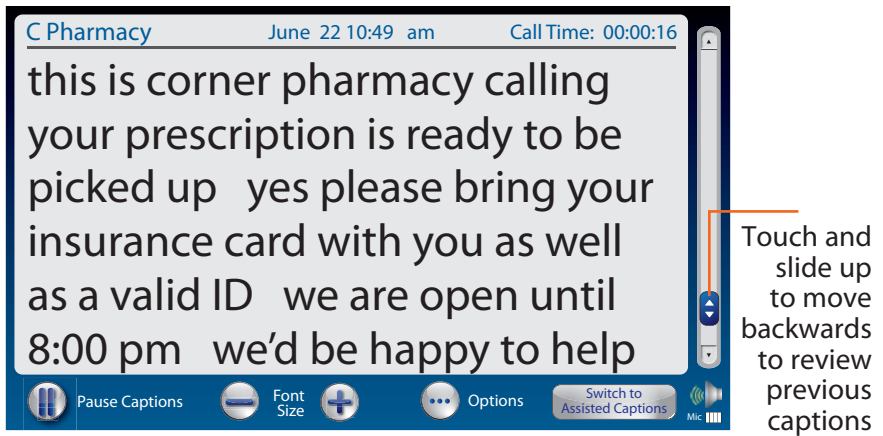

To review captions during a call:

1. Touch  (**Pause Captions**).

2. Then:

A: Touch and move the slide bar at the right up to scroll back through previous captions.

– OR –

B: Place your finger on the captions screen and swipe downward to review previous captions.





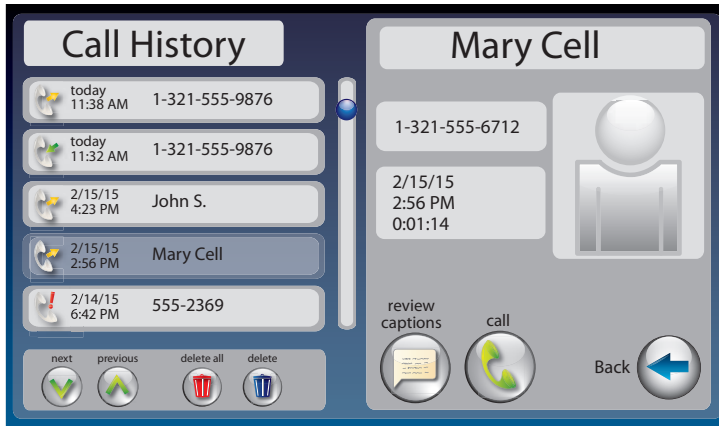

When you are finished reviewing captions, touch  (**Back to Live Captions**) to return to the current conversation. Anything the other party said during the time you were reviewing captions will appear, and the live captions will continue as usual.



NOTE *Your CapTel phone holds captions for up to 100 different conversations in memory (approximately 10 hours of conversations). If the conversation memory fills up entirely, older captions will be erased as new captions come in.*

Reviewing Captions After Hanging Up



To review captions after your conversation is ended and the phone is hung up:

1. On the display screen, touch  (**Call History**).
2. From the Call History listing on the left, touch the call that you wish to review. If needed, use the scroll bar or touch  and  to scroll through the list of calls.
3. Once the call you want is highlighted, information about the call appears on the right. Touch  (**review captions**) to review captions of the call. When reviewing captions: Touch and drag the scroll bar on the right to move backwards and forwards through captions. Touch  and  to see captions from a previous/later call.
4. When you are done reviewing captions, press  (**HOME button**) to exit.

TIP The Call History listing lets you know whether a call was  **incoming** or  **outgoing**.





NOTE Your CapTel phone comes with the Save Captions feature enabled, letting you view conversation captions after you've hung up the phone. You can turn this feature off so that CapTel will not save conversation captions after every call. Please see Saving Captions after Hang up on page 99 for instructions.

Saving Conversation Captions



You can set your CapTel phone to save captions after the call is ended. This allows you to go back and review what was said after you've hung up. You can review captions from up to 100 different conversations in memory. The default setting is Save Captions – ON.

To change the Save Captions setting:

1. On the display screen, touch  (**Settings**).
2. Touch  (**General Settings**).
3. Touch  (**Save Captions On**).
4. Touch  (**On**) or  (**Off**) to select.

Save Captions On saves conversation captions after the call is finished and the phone is hung up.

Save Captions Off erases the conversation captions after every call.

5. Once you have made your selection, press  (**HOME button**) to exit.



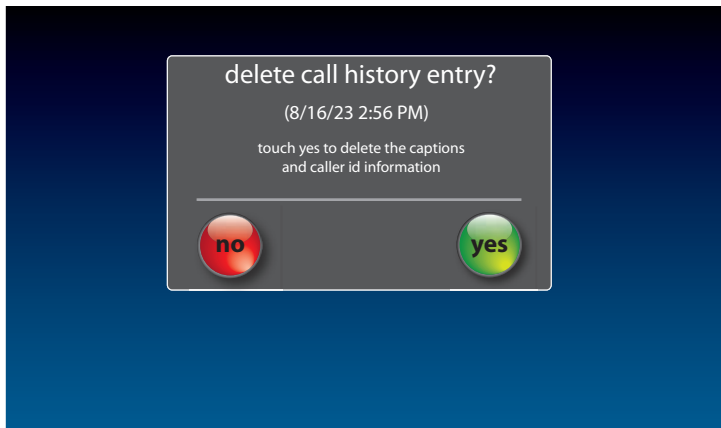

Erasing Captions







To erase captions of a single conversation after the call has ended:

1. From the display screen, touch  (**Call History**).
2. From the list on the left, touch the call that you want to review.

TIP *Touch and drag the scroll bar to see calls further up or down the list. You can use  (**Next/Prev**) to move up or down the list.*

3. Information about the call you selected appears in the right of the display.
4. Touch  (**Delete**) to delete this call from your Call History.
5. The display asks you to confirm if you want to delete the call. Touch  (**yes**) to delete or touch  (**no**) to exit.
6. When you are finished, press  (**HOME button**) to exit.

To erase all captions from Call History:

1. From the display screen, touch  (**Call History**).
2. Touch  (**Delete All**).
3. The display asks you to confirm if you want to delete all of your call history. Touch  (**yes**) to delete all call history entries, or touch  (**no**) to exit.
4. When you are finished, press  (**HOME button**) to exit.

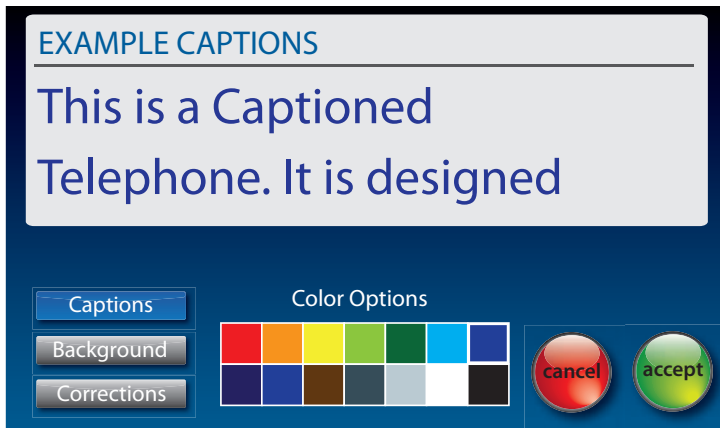

Changing the Color of the Captions



You can change the color of the captions font and background color on the display screen to a color combination that you prefer. You need to set the conversation colors before or after a call. You cannot change the captions colors during a live captioned call.

NOTE *Changing the font color applies only to conversation captions. The font size and style for your CapTel 2400i menu options always remains the same.*

To change the font and background colors:

1. On the display screen, touch  **(Settings)**.
2. Touch  **(Display)**.
3. Touch  **(Display Colors)**.

4. The display screen shows you an example of how the colors are currently set.

To change the Captions color:

1. Make sure  (**Captions**) is highlighted (blue).
2. In the Color Options table, touch the color that you would like the captions to appear. As you select your color, CapTel shows you an example of how the captions will look.

To change the Background color:

1. Touch  (**Background**) to highlight (blue).
2. In the Color Options table, touch the color that you would like the background to appear. As you select your color, CapTel shows you an example of how the background will look.

To change the Corrections color:

1. Touch  (**Corrections**) to highlight (blue).
2. In the Color Options table, touch the color that you would like the Corrections to appear. As you select your color, CapTel shows you an example of how the corrections will look.

5. When you have selected the color combination that you prefer, touch  (**Accept**) to save or  (**Cancel**) to exit.

6. When you are done, press  (**HOME button**) to exit.

TIP

If you have difficulty reading the captions, you may try different color combinations to create higher contrast between the captions color and the background color.









Changing the Captions Font Size and Style



You can adjust the font size and style of the conversation captions to make them easier to read.

NOTE *Changing the font size or style only applies to conversation captions. The font size and style for your CapTel menu options always remains the same.*

To change the font size of the captions:

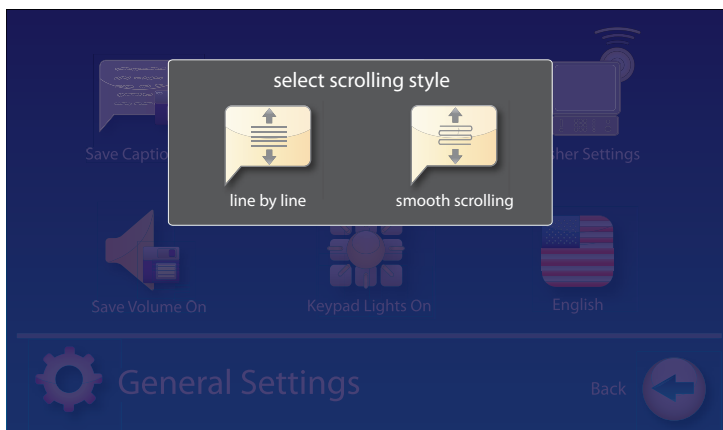

1. With the handset hung up, touch  (**Settings**).
2. Touch  (**Display**).
3. Touch  (**Font Settings**).
4. The display shows you what the current font size and style setting is. To change the font style, touch one of the five (5) style options available. To change the font size, touch  or .
5. When you have selected the font size and style that you prefer, touch  (**Accept**) to save your change or  (**Cancel**) to exit.
6. When you are done, press  (**HOME button**) to exit.

Setting how Captions Scroll Across the Display Screen



You can control how the captions appear on the display screen: either appearing word-by-word across the screen as each word is captioned or by smooth scrolling one line at a time in a continuous movement. The default setting is smooth scrolling.

To change the way captions scroll across the screen:

1. On the display screen, touch  (**Settings**).
2. Touch  (**General Settings**).
3. Touch  (**Smooth Scrolling**).
4. Touch the scrolling option that you prefer.

Line-by-Line Scrolling: captions appear word-by-word across the screen as they are captioned

Smooth Scrolling: captions appear one line at a time in a continuous motion

5. Once you have made your selection, press  (**HOME button**) to exit.



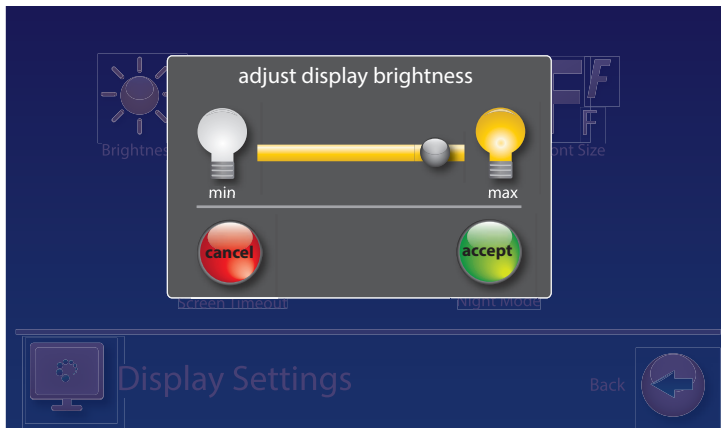



Adjusting the Brightness of the Display Screen



You can adjust the brightness of your CapTel display screen to make it easier to read in well-lit or dimly-lit environments.

NOTE *You need to adjust the brightness of the Display Screen before or after a call. You cannot set the display screen brightness during a live captioned call.*

To adjust the brightness of the Display Screen:

1. On the display screen, touch  **(Settings)**.
2. Touch  **(Display)**.
3. Touch  **(Brightness)**
4. Touch and drag the slide bar to adjust the brightness to the setting that you would like. Sliding left makes the display screen dimmer. Slide right to make the display screen brighter.
5. When the brightness is set, touch  **(Accept)** to save or  **(Cancel)** to exit.
6. Press  **(HOME button)** to exit.

NOTE *After 60 seconds of non-use, the CapTel display screen will start becoming more dim and gradually go completely dark as an energy-saving measure. To re-illuminate the screen, simply touch the display screen or any button on the dialing keypad.*

Call History



This section explains how to use Call History to see who has called you, to review captions of past conversations, and to see information about any incoming calls you may have missed.

TOPICS

- **Reviewing Previous Calls**
- **Reviewing Captions from a Previous Call**
- **Dialing from Call History**
- **Deleting Previous Calls**

About Call History

An indicator on the CapTel display screen shows you how many new calls are in your Call History list that you have not yet reviewed. When you touch  (**Call History**) and see the list of calls, the blue indicator resets so that it only shows the number of new calls that you have not yet seen.

The number of calls in Call History may be different than the number of Answering Machine messages you have, as some callers may choose not to leave a message.

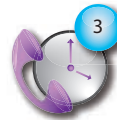

New calls indicator

Reviewing Previous Calls

Your CapTel phone keeps a list of information about recent calls, including calls that you may have missed. You can review captions from the call, the date and time of the call, and any Caller ID information if available. CapTel can even show you a picture of the caller if it is someone in your Contact list.

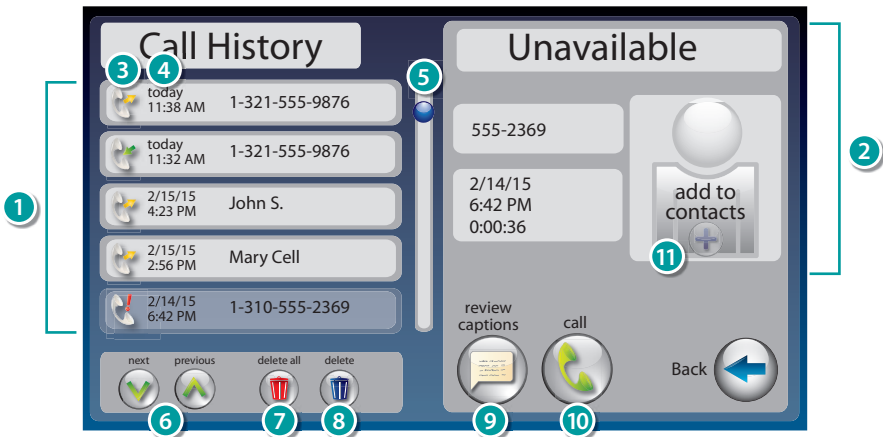

- 1 Previous calls: Touch the call you want information about.
- 2 Information about the call shows up here.
- 3 Indicates whether call was incoming, outgoing, or unanswered.
- 4 Date and time of the call.
- 5 Use the scroll bar to review entries further down the list.
- 6 Next/Previous: Lets you move up/down through entries in the list.
- 7 Delete all: Erases all calls in Call History.
- 8 Delete: Erases the selected call from Call History.
- 9 Review captions: Review captions of the call.
- 10 Call: Places a call to this person.
- 11 Add to Contacts: Adds caller to your Contacts list.

TIP

Remember to first touch the call listed in Call History on the left side of display that you want to review. Once you touch the call listing, more information about the call appears on the right of your screen, including a picture of the caller if you have added a picture for him/her in your Contacts list.



Reviewing Captions from a Previous Call







You can look back and see captions from any call in your Call History. To review captions from a previous call:

1. From the display screen, touch  (**Call History**).
2. From the list on the left, touch the call that you want to review.

TIP Touch and drag the scroll bar to see calls further up or down the list. You can use  (**Next/Prev**) to move up or down the list.

3. Information about the call that you selected appears in the right of the screen.
4. Touch  (**Review Captions**) to review captions of the call. If the call was not captioned originally, the display indicates “this call has no captions”.
5. Touch and drag the scroll bar at the right to move backwards and forwards through the captions.
6. When you are finished, press  (**HOME button**) to exit.

NOTE You can increase/decrease the size of the captions font by touching  or  at the bottom of the display.

NOTE Touch   (**<<prev / next>>**) to view captions from a previous/later call.

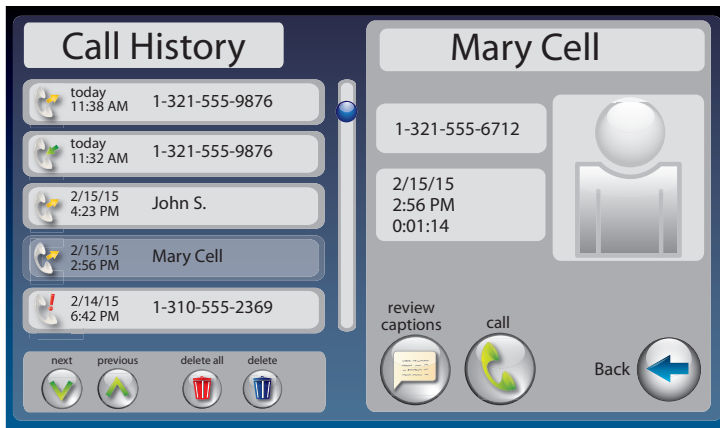

Dialing from Call History



You can use Call History to quickly re-dial someone that has called you before. This is especially helpful if you notice you've missed a call – you can call the person back directly from Call History.

To dial a number from Call History:

1. From the display screen, touch  (**Call History**).
2. From the list on the left, touch the call that you want to review.

TIP Touch and drag the scroll bar to see calls further up or down the list. You can use   (**Next/Previous**) to move up or down the list.

3. Information about the call that you selected appears in the right of the screen.
4. Touch  (**Call**) to place a call to this person.
5. If you are calling this number for the first time, the display asks you to select which format to use when dialing the phone number and shows you three different formats. For example, does CapTel need to dial a 1 or the area code first? Touch the correct number format (yellow indicator lights up).
6. Lift the handset. CapTel dials the number automatically.



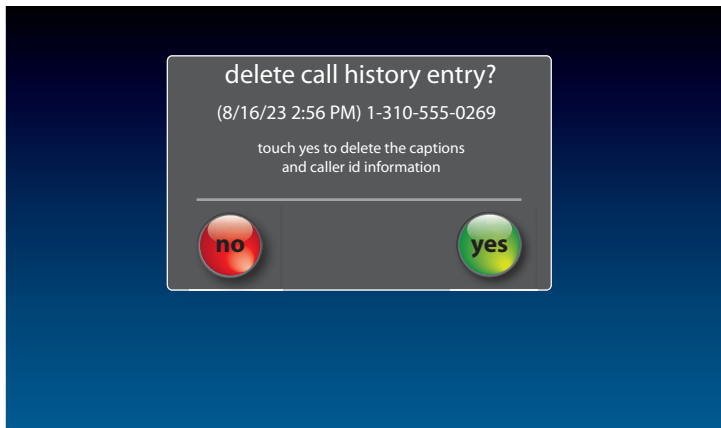

Deleting Previous Calls







To delete a single call from Call History:

1. From the display screen, touch  (**Call History**).
2. From the list on the left, touch the call that you want to review.

TIP *Touch and drag the scroll bar to see calls further up or down the list. You can use  (**Next/Prev**) to move up or down the list.*

3. Information about the call you selected appears in the right of the display.
4. Touch  (**Delete**) to delete this call from your Call History.
5. The display asks you to confirm if you want to delete the call. Touch  (**yes**) to delete or touch  (**no**) to exit.
6. When you are finished, press  (**HOME button**) to exit.

To delete all calls from Call History:

1. From the display screen, touch  (**Call History**).
2. Touch  (**Delete All**).
3. The display asks you to confirm if you want to delete all of your call history. Touch  (**yes**) to delete all call history entries, or touch  (**no**) to exit.
4. When you are finished, press  (**HOME button**) to exit.

Answering Machine



This section explains how to use the built-in Answering Machine and see captions of messages that people leave for you. You can hear the voice recording and read captions of the message. You can retrieve your Answering Machine messages remotely from a different phone, and CapTel can also show you captions of messages that are left on an external answering machine or in your Voicemail service.

TOPICS

- **About the Answering Machine**
- **Turning Answering Machine On/Off**
- **Playing Your Answering Machine Messages**
- **Erasing Answering Machine Messages**
- **Deleting All Messages**
- **Recording a Personal Greeting**
- **Remote Message Retrieval**
- **Captioning Messages from an External Answering Machine**
- **Setting the Ring Count**
- **Playing Incoming Messages Aloud/Silent**
- **Seeing Captions of your Voicemail Messages**

About the Answering Machine

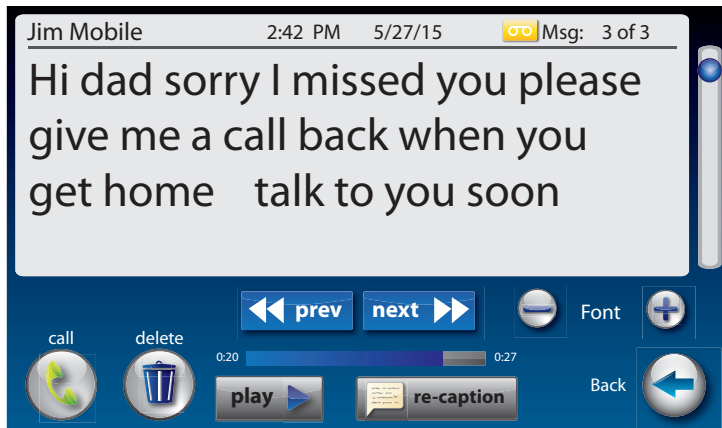

Your CapTel phone can take messages for you when you are unavailable, for you to play back later. When checking your messages, you can listen to the messages as well as read captions. The CapTel Answering Machine saves up to 100 messages. Each message can be up to 90 seconds long.



If you have more than one answering machine in your home or office, make sure only one answering machine device is turned on/active at a time. If you rely on voicemail service for messages, the CapTel Answering Machine should be turned off.

If you prefer to use the Voicemail feature provided by your telephone service, please see "Seeing Captions of Your Voicemail Messages" on page 65.

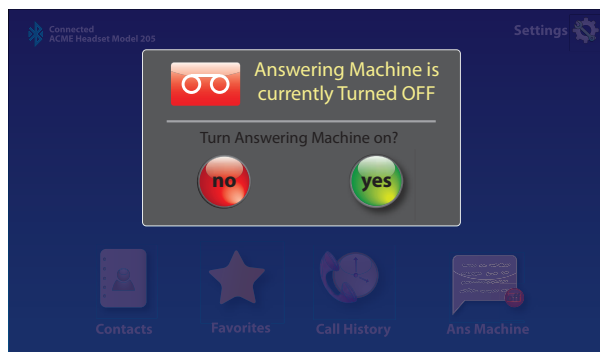

Turning Answering Machine On/Off









To turn Answering Machine on:

1. The first time you set up your Answering Machine: on the display screen, touch  **(Ans Machine)**.
2. The display screen shows you the current setting (on or off). Touch  **(yes)** to turn the Answering Machine on.

TIP A green  **on** indicator appears on the Answering Machine icon to let you know at a glance whenever the Answering Machine is turned on.

NOTE After the first instance, turn Answering Machine on by touching  **(Settings)**,  **(Messages)**,  **(Answering Machine)**, then  **(Answering Machine off)**.

To turn Answering Machine off:

1. From the display screen, touch  **(Settings)**.
2. Touch  **(Messages)**.
3. Touch  **(Answering Machine)**.
4. Touch  **(Answering Machine On)**.
5. The display asks you if you want the **answering machine on or off?** Touch  **(off)**.
6. When you are finished press  **(HOME button)** to exit.

Playing Your Answering Machine Messages

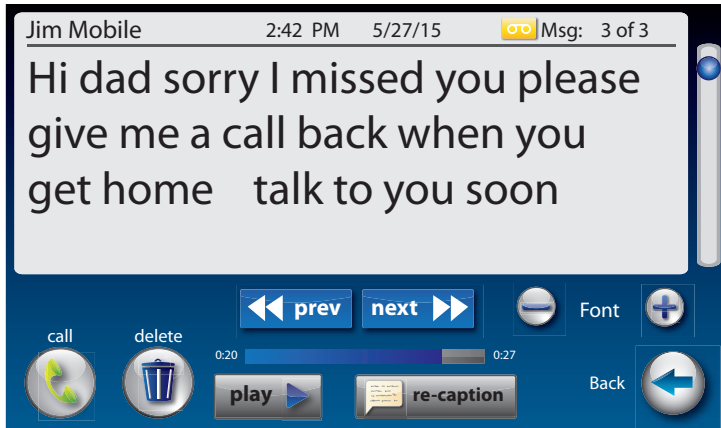



1. The display screen indicates unread messages waiting.

2. Touch  (**Ans Machine**).







3. A list of your messages appears on the left of the display, with the most recent call highlighted. Select and touch the message you want to review.

4. Information about the highlighted call appears on the right of the display.

5. Touch  (**PLAY**), then lift the CapTel handset to listen to your message. Or press  (**SPEAKER button**) to play messages aloud.

6. When you are done listening/reading messages, you can:

- Touch  (**<<prev / next>>**) to view captions from a previous/ later message. Messages are in date received order, most recent first.
- Touch  (**Call**) to place a call to this person.
- Touch  (**Delete**) to erase the Answering Machine message and captions.
- Touch  (**re-caption**) to get new captions of this message.
- Touch  (**PLAY**) to play the message/captions again.



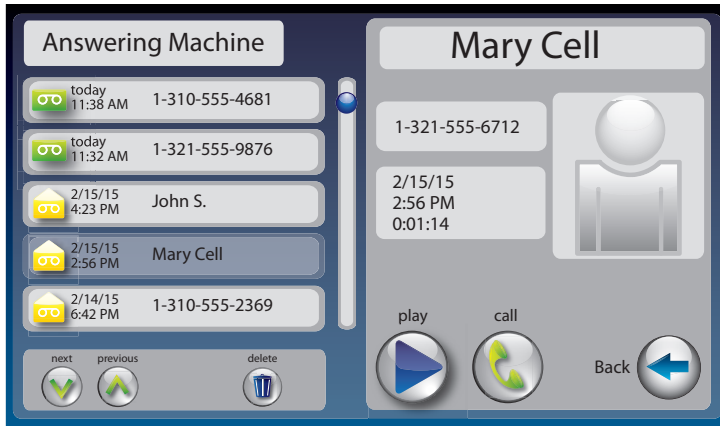

If you play your message and there are no captions, press the CAPTIONS button (blue light on). The voice message will play again, showing captions.

TIP *If you are playing your Answering Machine messages, and an incoming call occurs, you can send the call directly to the Answering Machine to listen to it later.*

Erasing Answering Machine Messages



To erase an individual Answering Machine message:

1. The display screen lets you know when you have unread messages waiting.
2. Touch  (**Ans Machine**).
3. Select and touch the call you want to review from the Answering Machine list on the left side of the display. The most recent call is highlighted.
4. Information about the call you selected appears on the right side of the display.
5. Touch  (**PLAY**) to listen to your message and see the captions.
6. To delete the message, touch  (**Delete**). The display asks you to confirm you want to delete the message. Touch  (**yes**) to delete or touch  (**no**) to cancel.

When you are finished erasing your messages, press  (**HOME button**) to exit.





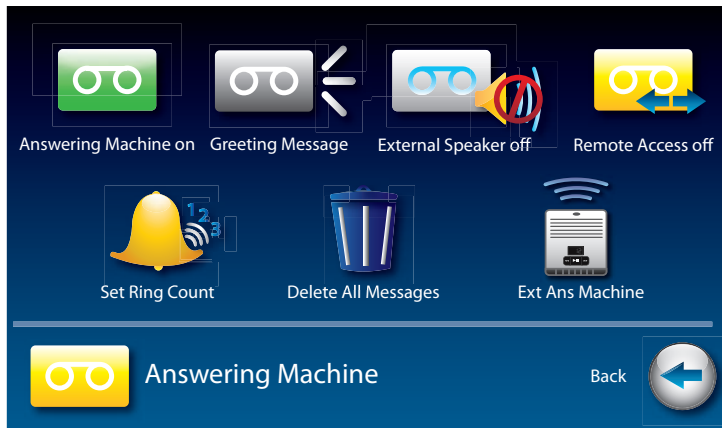

NOTE *In addition to erasing messages one at a time, you can delete all calls at once. See page 56 for instructions.*

Deleting All Messages



In addition to erasing Answering Machine messages one at a time as you play them, you can also erase all your saved Answering Machine messages at one time.

To delete all your Answering Machine messages:



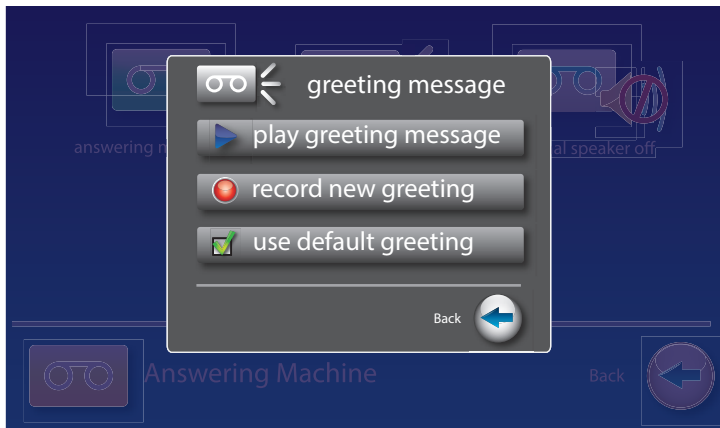

1. From the display screen, touch  (**Settings**).
2. Touch  (**Messages**).
3. Touch  (**Answering Machine**).
4. Touch  (**Delete All Messages**).
5. The display asks you to confirm you want to **delete ALL messages**. Touch  (**yes**) to delete or touch  (**no**) to cancel.
6. Press  (**HOME button**) to exit.



Recording a Personal Greeting



You can record a personal greeting for your CapTel phone to use whenever the Answering Machine takes messages. If you do not want to record a personal greeting, the Answering Machine will use a pre-recorded greeting that says: *"Hello. No one is available to take your call. Please leave a message after the tone."*



To record a personal greeting:

1. From the display screen, touch  (**Settings**).
2. Touch  (**Messages**).
3. Touch  (**Answering Machine**).
4. Touch  (**Greeting Message**).

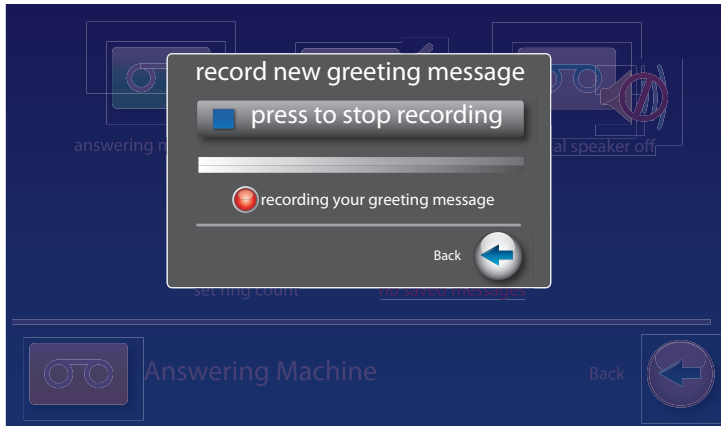

TIP To hear the greeting that is currently being used, lift the handset or press  (**Speaker button**) and touch  (**play greeting message**). You will be able to hear the current greeting over the speaker or in the CapTel handset.

5. Touch  (**record new greeting**) to record your personal message.



6. Lift the CapTel handset and touch  (**press to start recording**).
7. Speaking into the CapTel handset, record the personal greeting you would like the Answering Machine to use. When you are finished recording, touch  (**press to stop recording**).

NOTE *You can also record a greeting by pressing the Speaker button instead of using the CapTel handset.*

8. If you are not satisfied with your personal greeting, you can re-record it. Just repeat steps 4–6 above.
9. When you are satisfied with your personal greeting, touch  (**Accept**). Hang up the CapTel handset.
10. Press  (**HOME button**) to exit.

Remote Message Retrieval

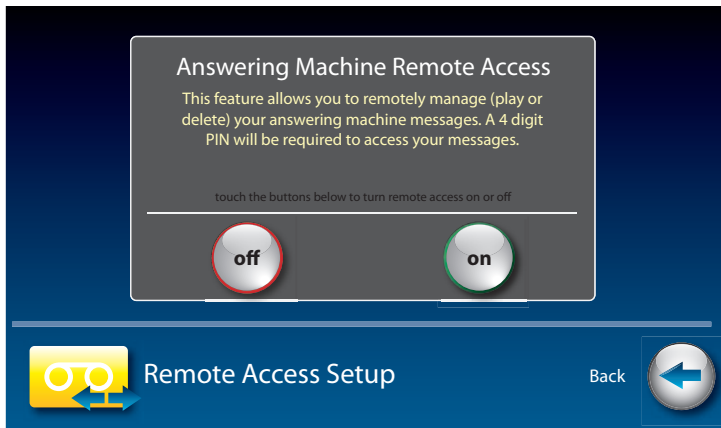







CapTel lets you call in to play your Answering Machine messages when you are away from your home or office. This feature must be turned on and you must set a personal identification number (PIN) for security before this feature will work.

The default setting for Remote Access is OFF.

NOTE

If possible, use a different CapTel phone when calling in to retrieve your messages, in order to be able to see captions of the messages. If you call using any other phone, you will be able to listen to the voice part of the Answering Machine messages but you will not be able to read captions at your remote location.

To turn Remote Message Retrieval on:

1. From the display screen, touch  (**Settings**).
2. Touch  (**Messages**).
3. Touch  (**Answering Machine**).
4. Touch  (**Remote Access off**).
5. Touch  (**On**) or  (**Off**) to select.

6. CapTel shows the default 4-digit Remote Access PIN. This is the number you need to enter when calling in remotely to play your Answering Machine messages.

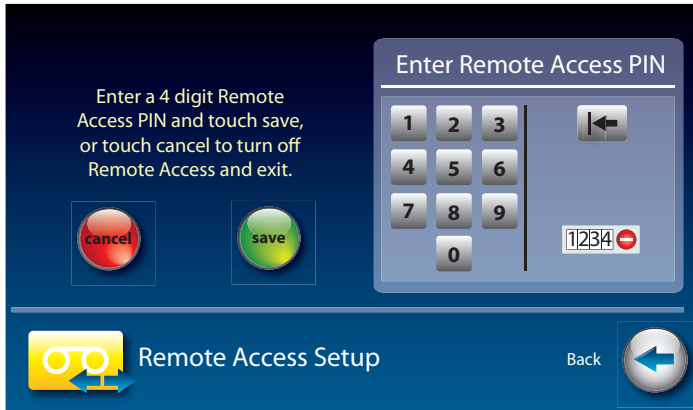

You should change the PIN to a different number for your own use. Touch the four digits on the display screen that you want to use. The selected PIN appears on screen to confirm your selection.

TIP Be sure to write your PIN down for your own reference.

7. When you have the PIN that you want, touch  (**save**).
8. CapTel confirms the PIN number you have saved and shows a list of remote access commands. Use these commands when calling in to get your messages remotely.

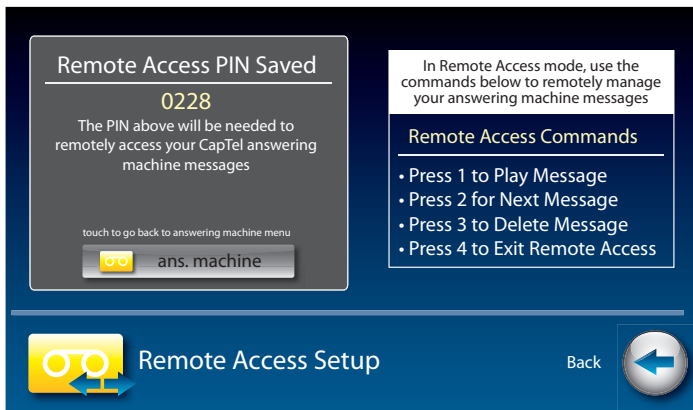

9. When you are finished, press  (**HOME button**) to exit.

To Access Your Answering Machine Messages Remotely

1. From a different phone, call your own CapTel phone number and let it ring until the Answering Machine greeting begins.
2. Once you hear/read the BEEP, enter your 4-digit PIN by pressing keys on the dial pad of the phone that you are calling from.
3. Your CapTel 2400i SPK will start playing aloud any recorded messages (starting with the most recent one) for you to hear. If you are calling from a different CapTel phone, you will be able to see captions of the messages while they are played.

After each message is played, there is a pause that lets you enter one of the following commands on the phone's dial pad:

- Press 1 – Play Message**
- Press 2 – Go to Next Message**
- Press 3 – Delete Message**
- Press 4 – Exit Remote Access**

If you do not press any of the dial pad keys, after 30 seconds your CapTel 2400i will automatically hang up.

4. When you are done, hang up the phone you are calling from.

TIP



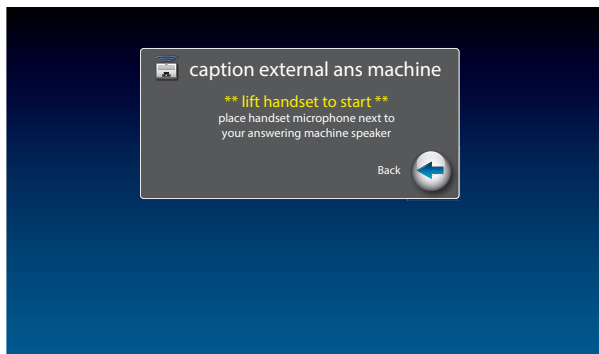

If possible, use a different CapTel phone when calling in to retrieve your messages, in order to be able to see captions of the messages. If you call using any other phone, you will be able to listen to the voice part of the Answering Machine message but you will not be able to read captions at your remote location.

Captioning Messages from an External Answering Machine



In addition to the built-in answering machine that comes with your CapTel phone, you can also see captions of voice messages that are left on an external answering machine (a separate answering machine you may own, not the one built into the CapTel phone).

To get captions of your external answering machine messages:

1. From the display screen, touch  (**Settings**).
2. Touch  (**Messages**).
3. Touch  (**Answering Machine**).
4. Touch  (**Ext Ans Machine**).
5. Lift the CapTel handset and place it next to your external answering machine speaker. Make sure the mouth-piece of the handset is next to the speaker of your answering machine. While you do this, your CapTel phone connects to the captioning service.
6. Press the PLAY button on your external answering machine, so that the messages are played aloud.

The display will show captions of the messages as they are played.

NOTE *While checking messages, you may operate your external answering machine the same way you normally do, using features such as play, re-play, delete, or save messages.*

When you are done listening/reading captions, hang up the CapTel handset.



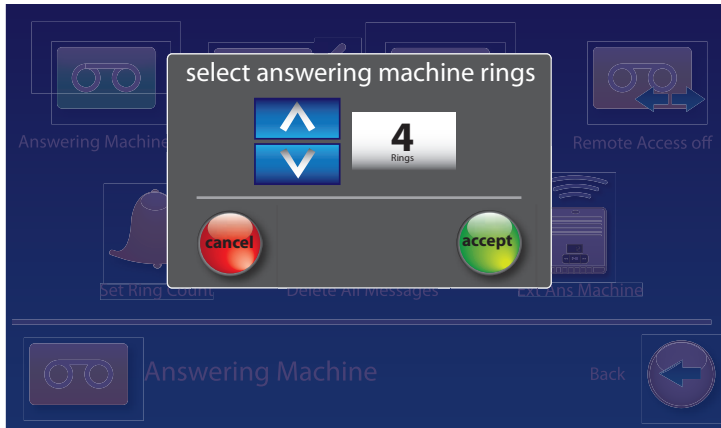



Setting the Ring Count



You can set the approximate number of times the CapTel will ring before the Answering Machine answers the call. The default setting is four (4) rings, but you can set it to be any number of rings between two (2) and twenty (20).

NOTE *The ring count may be slightly different in telephone systems that use “distinctive” ring patterns. Please experiment with this setting as needed for your specific telephone system.*

To set the number of rings before answering:





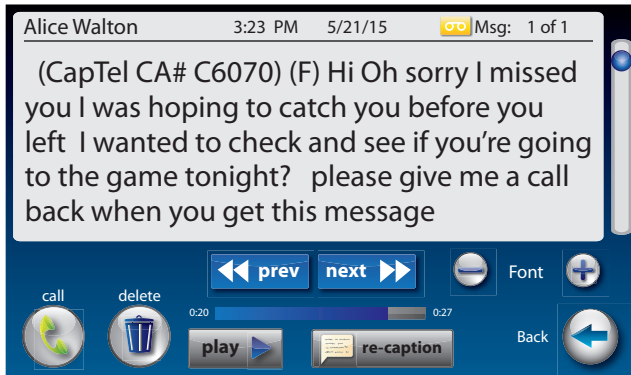

1. From the display screen, touch  **(Settings)**.
2. Touch  **(Messages)**.
3. Touch  **(Answering Machine)**.
4. Touch  **(Set Ring Count)**.
5. Touch the  **(arrows)** to select the number of rings you'd like to use, then touch  **(Accept)**.
6. Press  **(HOME button)** to exit.

Playing Incoming Messages Aloud/Silent



Just like with other Answering Machines, you can “screen” callers by having incoming messages played aloud on the CapTel phone for before you answer the call. While this is a convenient feature, there may be times when you do not want incoming messages to be played aloud, but instead recorded silently for you to review at a later time. The default setting is for incoming messages to be muted (silent).

To make incoming calls audible or set them to be silent:

1. From the display screen, touch  (**Settings**).
2. Touch  (**Messages**).
3. Touch  (**Answering Machine**).
4. Touch  (**External Speaker Off**).
5. The display asks if you want to  (**turn on**) or  (**turn off**) the answering machine speaker. Touch the option you want.
6. Press  (**HOME button**) to exit.

TIP You can “screen” incoming Answering Machine messages by listening to the caller and reading the captions while the message is recorded. Make sure that the Answering Machine Speaker is set to “On”. If you choose to answer the call, just pick up the handset and begin talking.

TIP You can also send an incoming call directly to the answering machine to take a message if you are busy. Just touch  (**Send to Ans Machine**).

Seeing Captions of Your Voicemail Messages

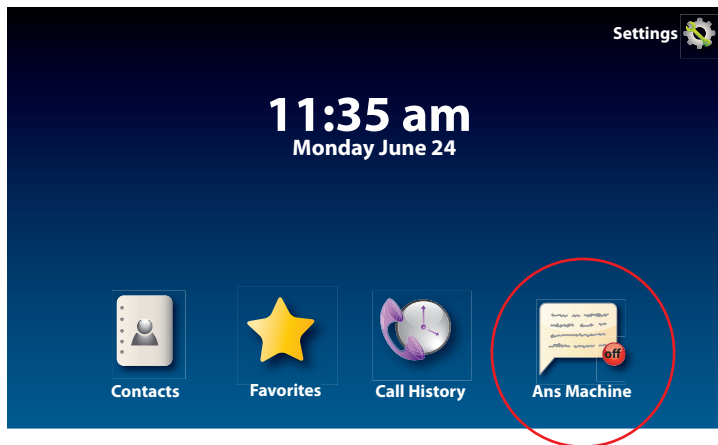

Your telephone service may provide a Voicemail feature that lets callers leave a message through your telephone service. Your CapTel phone can indicate when you have Voicemail messages waiting to be listened to.

Voicemail is different than the built-in CapTel Answering Machine, which records messages directly on your phone. CapTel lets you choose between getting messages either on the built-in Answering Machine or through your telephone service's Voicemail system.

To retrieve Voicemail messages, you need to call into your Voicemail service to play the messages over the phone line. Before you turn the Voicemail Indicator on, it's important to know what phone number you need to call in order to access your Voicemail service.







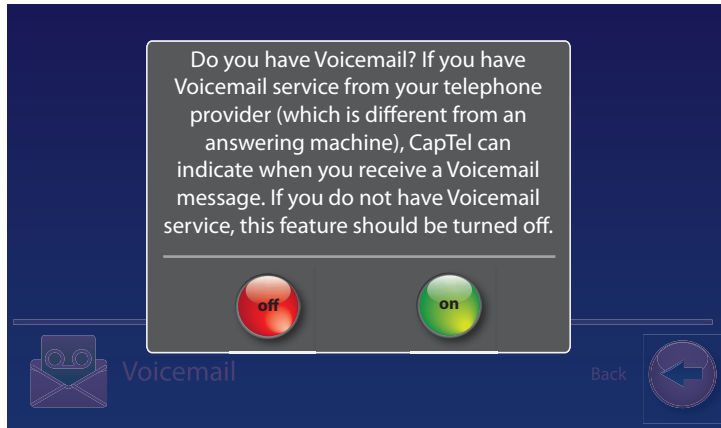

Voicemail services and commands vary by telephone provider. To learn about the specific Voicemail capabilities on your telephone line, contact your telephone service provider directly.

Do not turn on the Voicemail Indicator if you are not sure whether you have Voicemail service, or if you do not know the number to call into to retrieve your Voicemail messages. The default setting is Voicemail Indicator off.

Turning the Voicemail Indicator On



To turn on the Voicemail Indicator:

1. From the display screen, touch  (**Settings**).
2. Touch  (**Messages**).
3. Touch  (**Voicemail**).
4. Touch  (**enter voicemail phone number**).
5. Using the display screen, enter the phone number you need to dial to access your Voicemail system. In some cases, this may be your own phone number or a shortcut such as *98.
6. When you are satisfied with the number, touch  (**save**).
7. Now, touch  (**Voicemail off**).
8. To turn on Voicemail, touch  (**on**).
9. The display screen confirms that Voicemail is on, and lists the phone number you have entered. Press  (**HOME button**) to exit.

On the CapTel display screen, the  (**Ans Machine**) changes from "Ans Machine" to "Messages" to let you know that your phone is ready to check for new Voicemail messages.

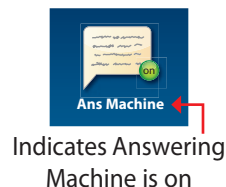



Listening to Your Voicemail Messages

When you receive Voicemail messages, a green Voicemail indicator appears on the CapTel display screen to alert you.



Indicates new Voicemail messages waiting

To listen to your Voicemail messages:

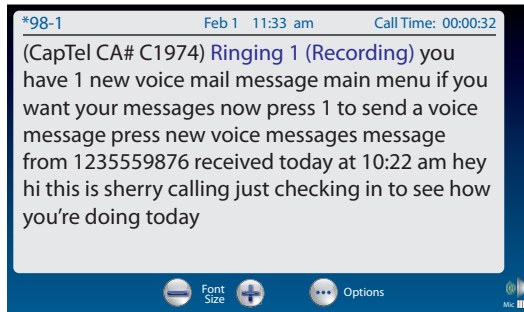

1. On the display screen, touch  (**Messages**).
2. If needed, touch  (**Connect with Voicemail**).
3. Lift the CapTel handset to dial your Voicemail service, or press  (**SPEAKER button**).
4. CapTel dials into your Voicemail service. Watch the captions to follow instructions for retrieving and managing your messages. You will see captions of your messages on the display screen as they are played aloud over the line.

Voicemail commands vary by service. Follow the prompts in the captions to navigate your Voicemail service (Example: “press 1 to review messages, press 2 to delete”, etc.). Press the dial pad keys on the CapTel phone as indicated.









5. When you are finished, hang up the phone to end the call.

NOTE

The  Voicemail indicator appears when you have new Voicemail messages that you have not listened to yet. Once you dial in to retrieve and “clear” your new Voicemail messages, the  Voicemail indicator goes away, even if you save some of your messages. That way, you will always be alerted when there are new Voicemail messages waiting.

Turning the Voicemail Indicator Off

To turn off the Voicemail Indicator:

1. From the display screen, touch  (**Settings**).
2. Touch  (**Messages**).
3. Touch  (**Voicemail**).
4. Touch  (**Voicemail on**).
5. Touch  (**Voicemail off**). The icon will change to red to indicate Voicemail is turned off.
6. Press  (**HOME button**) to exit.

NOTE *Even when the Voicemail Indicator is turned off, CapTel remembers the dial-in number you entered, making it easy to turn Voicemail back on when you are ready to use it again.*

Voicemail Tips

- The Voicemail Indicator only works if you have a Voicemail service set up on your telephone line. If you do not have Voicemail service, or do not know if you have Voicemail service, please check directly with your telephone service provider before turning the Voicemail Indicator on.
- Make sure you know the phone number you need to call into to retrieve your Voicemail messages. In many cases, you dial your own phone number or some shortcut such as “*98”.
- It is helpful to turn OFF the CapTel Answering Machine when you want to use Voicemail to get your messages instead.
- If the VM Indicator turns red () , please check your Voicemail messages. New messages may be waiting that did not “trip” the indicator. Checking for messages helps verify and resets the indicator accordingly.
- The very first time you turn the Voicemail Indicator “on”, go ahead and check for Voicemail messages by touching the Messages icon. Checking messages resets the indicator, and gives you practice on how to use the feature.

Troubleshooting Tips for Voicemail

If you have questions about the Voicemail Indicator, please check these common troubleshooting tips before contacting CapTel Customer Service. Be aware that some VoIP services, such as MagicJack, do not support the Voicemail feature.

Which feature should I use—the Answering Machine or Voicemail Indicator?

You can only use the Voicemail feature if your telephone service provides a Voicemail option and you know the phone number needed to access that Voicemail service. Otherwise, the choice is up to you. Both approaches will take messages from your callers and CapTel will show captions of your messages.

What number do I call in to check my Voicemail service?

That depends on your telephone service, which provides the Voicemail option. You need to check with your own telephone service provider to get the correct phone number. In some cases, the number may be your own phone number or a shortcut like “*98”, or you may need to include 1+area code. CapTel Customer Service cannot tell you what that number is, it depends on your specific telephone service.

How do I know whether the Answering Machine or Voicemail Indicator is on?

Your CapTel phone comes with both the Answering Machine and the Voicemail Indicator turned off. To use either feature, you need to first turn it on. We recommend that you use only use one feature at a time. If you choose to use Voicemail, then turn off the built in Answering Machine.

The CapTel display screen indicates which feature is on.



Answering Machine OFF /
Voicemail Indicator OFF



Voicemail Indicator ON /
Answering Machine OFF



Answering Machine ON /
Voicemail Indicator OFF



Voicemail Indicator ON /
Answering Machine ON

Why don't I see the number of Voicemail messages waiting for me?

Because Voicemail messages are saved by your telephone service and not by the CapTel phone, you need to check your messages (call into your service) in order to learn how many messages are waiting. The CapTel display shows you when there are new Voicemail messages available, so you know to check, but it cannot show you how many messages are available.

I see a number on the screen, but when I check Voicemail there are not that many messages.

Unlike Voicemail, the CapTel Answering Machine can tell you how many messages you have available. The number appears on the Ans Machine / Messages icon. The number indicates the Answering Machine messages only. CapTel cannot show how many Voicemail messages your telephone service has waiting, it only shows whether new Voicemail messages are available or not. To avoid confusion, use only one feature at a time—either turn off the Answering Machine or turn off the Voicemail indicator.



Why is the Voicemail indicator red?

If the Voicemail indicator turns red (VM), please check your Voicemail messages. New messages may be waiting that did not “trip” the indicator. Checking for messages helps verify and resets the indicator accordingly.

I know people have left Voicemail messages, but I am not seeing the Voicemail Indicator?

If you are certain you have Voicemail service turned on but you do not see the Voicemail indicator when people leave messages, check with your telephone service provider to confirm that the “VMWI (voice message waiting indicator)” setting is turned on and active for your telephone line.

Calling your Voicemail Service

As an alternative, you do not need to use the Voicemail Indicator feature to check Voicemail messages left on your telephone service. Simply use the CapTel dial pad to call into your voicemail system and “log in” the same way you would with any other telephone. Make sure the CAPTIONS light is on. As your voicemail messages are played, you will see captions on the display screen. Use the CapTel dial pad to select options in your voicemail menu system.

Contacts



This section explains how to save frequently called numbers in your contact list for easy and quick dialing.

TOPICS







- **Adding a New Contact**
- **Dialing a Phone Number in Your Contact List**
- **Editing an Existing Contact**
- **Removing a Contact**
- **Adding a Contact to Speed Dial**
- **Adding Contacts from your Mobile Device**
- **Adding a Photo to a Contact**

Adding a New Contact



You can save up to 100 names in your contact list for quick and easy dialing.

To add a new contact:

1. From the display screen, touch  (**Contacts**).
2. Touch  (**add new contact**).
3. Use the on-screen keyboard to type in the First Name of the person you want to add.
4. Touch the field next to “**Last**” to move down, then use the on-screen keyboard to enter the last name of the person.
5. You can be specific about which number(s) you are adding:  (**Mobile**),  (**Home**), or  (**Work**). Touch the field(s) next to the number(s) you’d like to add to begin entering.
6. When you are finished entering the Contacts information, touch  (**save**). The new contact appears on the left side of your Contacts list.
7. When you are finished, press  (**HOME button**) to exit.

TIP You can add a photograph of your contact person to each entry. Pictures can be entered at the MyContacts website, then synced to your phone. See *Adding a Photo to a Contact* on page 78 for instructions.



TIP You can add contacts to your Speed Dial or Favorites list. See pages 77 and 92 for instructions.



Dialing a Phone Number in Your Contact List



To easily dial someone in your contact list:

1. From the display screen, touch  (**Contacts**).
2. Under the Contacts list on the left side of the display, find and touch the name of the contact you wish to call. To see contacts further down the list, touch and drag the scroll bar.

TIP Touch   (**Next/Previous**) to move up/down through entries in your Contacts list.

3. On the right side of the display, touch the phone number of the person you want to call:  (**Mobile**),  (**Home**), or  (**Work**). CapTel will dial the number automatically for you.
4. Lift the handset to dial.

TIP You can identify any contact person as a **“favorite”** for easy dialing. At the Add/Edit Contacts page, touch  (**favorite**). See page 92 for instructions.





Editing an Existing Contact



To make changes to a contact in your list:

1. From the display screen, touch  (**Contacts**).
2. Under the Contacts list on the left side of display, find and touch the name of the contact you wish to edit. To see contacts further down the list, touch and drag the scroll bar. Information about the contact you selected appears on the right side of the display.

TIP Touch  (**Next/Prev**) to move up/down through entries in your Contacts list.

3. On the right side of the display, touch  (**Edit**) to go to the Add/Edit Contact screen.
4. Touch the field that you want to change, then use the on-screen keyboard to type in the new information. Touch the next field you want to edit, or move between fields by touching  (**return**). Touch  to erase the entire contents of a field.
5. When you are finished editing the contact, touch  (**save**). The new contact information will be saved in your contact list.
6. When you are finished, press  (**HOME button**) to exit.

TIP You can add a photograph of your contact person to each entry. Pictures can be entered at the MyContacts website, then synced to your phone. See *Adding a Photo to a Contact* on page 78 for instructions.



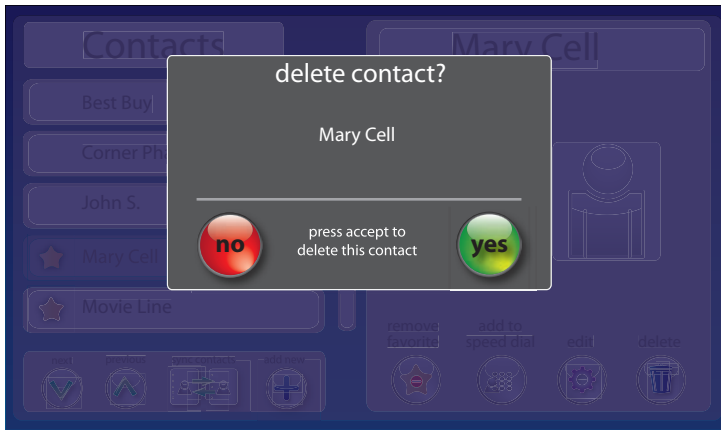

Removing a Contact



To remove a single contact from your list:

1. From the display screen, touch  (**Contacts**).
2. Under the Contacts list on the left side of the display, find and touch the name of the contact you wish to remove. Touch and drag the scroll bar to see contacts further down the list.

TIP Touch  (**Next/Prev**) to move up/down through entries.

3. On the left side of the display, touch  (**Delete**) to remove the person from your contacts.
4. CapTel asks you to confirm you want to delete the contact. Touch  (**yes**) to remove the contact or  (**no**) to exit.
5. When you are finished, press  (**HOME button**) to exit.

Adding a Contact to Speed Dial

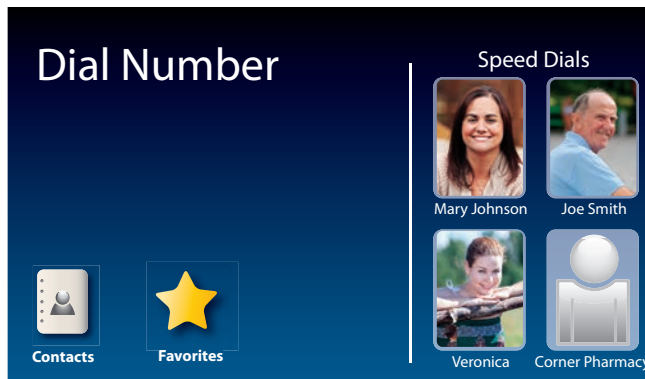





You can set up to four (4) Contacts to be added to Speed Dial. Speed Dial entries appear every time you lift the CapTel handset, for quick one-touch dialing. You can even add photos to your Speed Dial entries for easy dialing by picture.

To add a Contact to Speed Dial:

1. From the display screen, touch  (**Contacts**).
2. In the Contacts list on the left side of the display, find and touch the name of the person you want to add to Speed Dial. To see contacts further down the list, touch and drag the scroll bar.

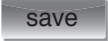
TIP Touch  (**Next/Prev**) to move up/down through entries.

3. On the right side of display, touch  (**Edit**). Touch  (**Speed Dial**).
4. If there are multiple phone numbers for this contact, the display asks which phone number (mobile, home, or work) you want to make a speed dial. Touch the number(s) you want, then touch  (**Accept**). A little graphic appears by the appropriate phone number to indicate it is added to Speed Dial.
5. Touch  (**save**).
6. When you are finished, press  (**HOME button**) to exit.

Now, when you pick up the handset, this contact will appear automatically on the display screen. Simply touch the person's name or image to dial.

TIP You can add a photograph of your contact person to each Speed Dial entry. See instructions on page 78.

Adding a Photo to a Contact



Using your computer, you can add photos to your Contact List to make it easy to dial by picture on your CapTel 2400i. You can also add, change, or delete Contacts on your computer, then download the changes directly to your CapTel 2400i phone.

Managing your Contact List is easy to do, but it takes two steps. First, go online and make changes at the MyContacts website. Then, “sync” with your CapTel 2400i to download the changes directly to your phone. Please see pages 79–89 for full instructions.

TIP *If someone helped set up your CapTel phone, you may want to consult with them as you manage Contact Lists on your computer.*

NOTE *If you do not have computer access, you can still add, delete, and change entries in your Contact List by using the touchscreen menu on the CapTel. Access to the MyContacts website is required, however, to add photos to your Contact List.*

Managing Your Contacts List

The MyContacts website helps manage the Contacts List on your CapTel phone. You can add new contacts, phone numbers, and even photos, then “sync” them with your CapTel 2400i.

NOTE

Because both the CapTel phone and the MyContacts website need to be set in sync mode, the sync process is easiest when the computer you are using and the CapTel phone are located close together. If the phone is in a different location than the computer, it may be helpful to have two people – one by the phone, one at the computer – to help the sync process go smoothly.

To manage your Contacts List:

1. On a computer that has Internet access, go to the website:
<https://MyContacts.CapTel.com>

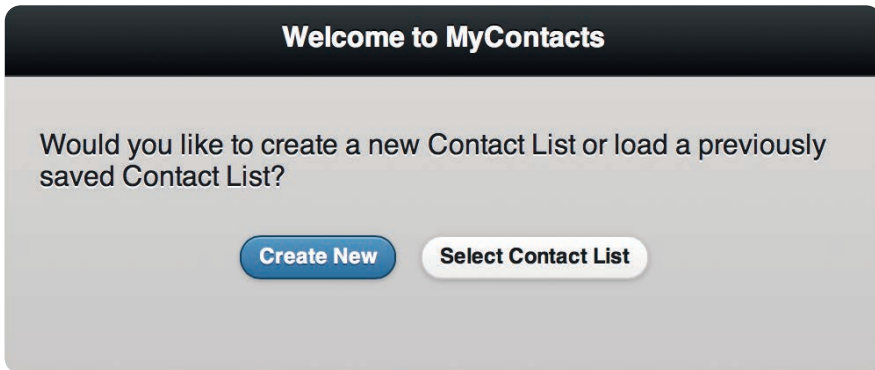

2. The website asks “Would you like to create a new Contact List or load a previously saved Contact List?” Click on  (**Create New**).

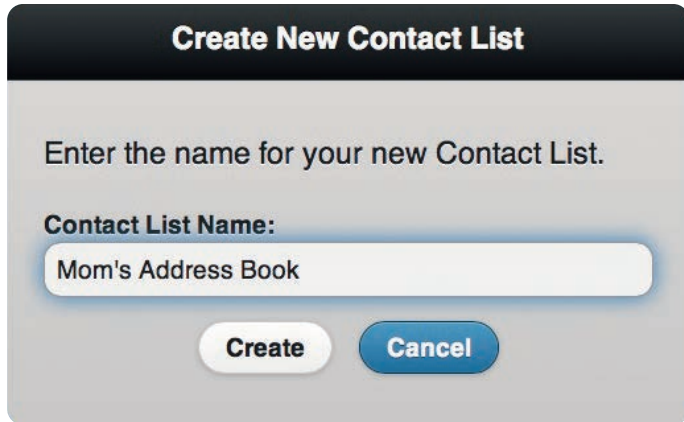

3. Enter the name you would like to use for your new Contact List, then click on **Create** (**Create**).

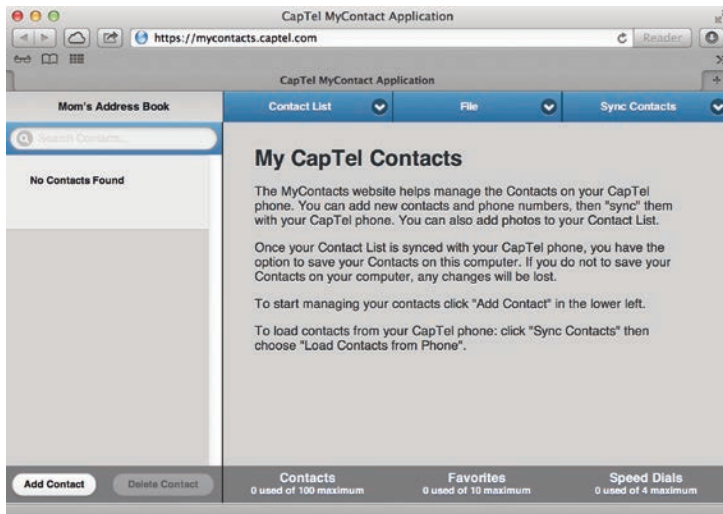

4. Click on **Add Contact** (**Add Contact**).

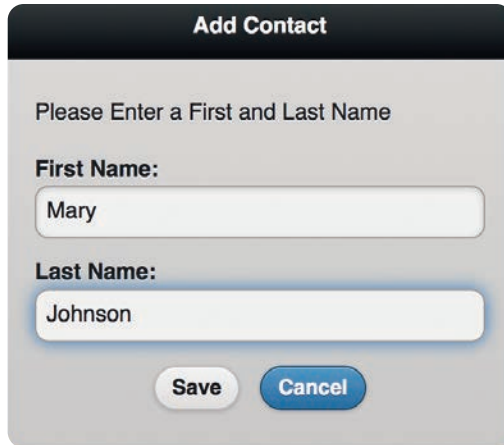

Add Contact

Please Enter a First and Last Name

First Name:
Mary

Last Name:
Johnson

Save Cancel

5. Enter the first and last name of your contact, then click on **Save** (**Save**).
6. Add the phone number information for your contact. Use the tab key to move between fields. Click on **Save Contact** (**Save Contact**) when information is entered.

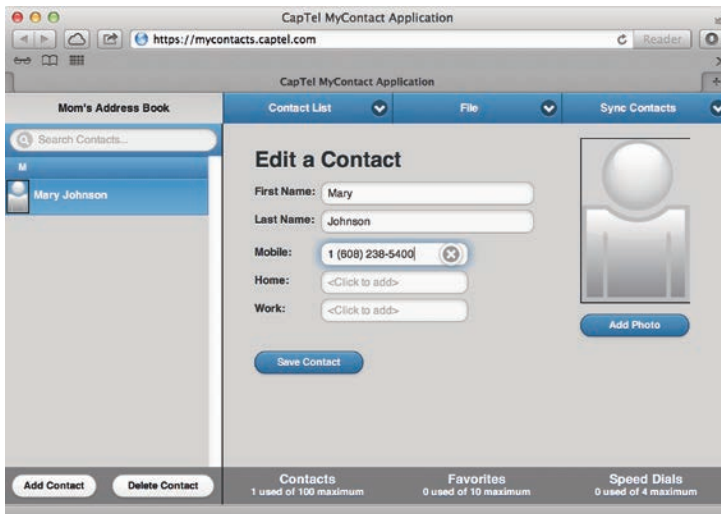

CapTel MyContact Application

https://mycontacts.captel.com

CapTel MyContact Application

Mom's Address Book

Search Contacts...

Mary Johnson

Edit a Contact

First Name: Mary

Last Name: Johnson

Mobile: 1 (808) 238-5400

Home: <Click to add>

Work: <Click to add>

Add Photo

Save Contact

Add Contact Delete Contact

Contacts 1 used of 100 maximum

Favorites 0 used of 10 maximum

Speed Dials 0 used of 4 maximum

To add a photo to this contact: click on **Add Photo** (**Add Photo**).



The website lets you browse your computer to select and save an existing photo. The photo files can be in jpg, png, or gif format.

Click on **Select Photo** (**Select Photo**), find and select the photo that you want to add.

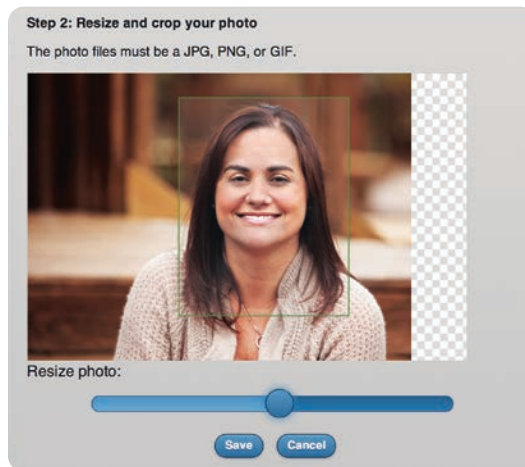

Once your photo is selected, you may re-size or crop the image to fit nicely in the CapTel display window. Only the part of the image inside the green shaded box will appear on your CapTel display.

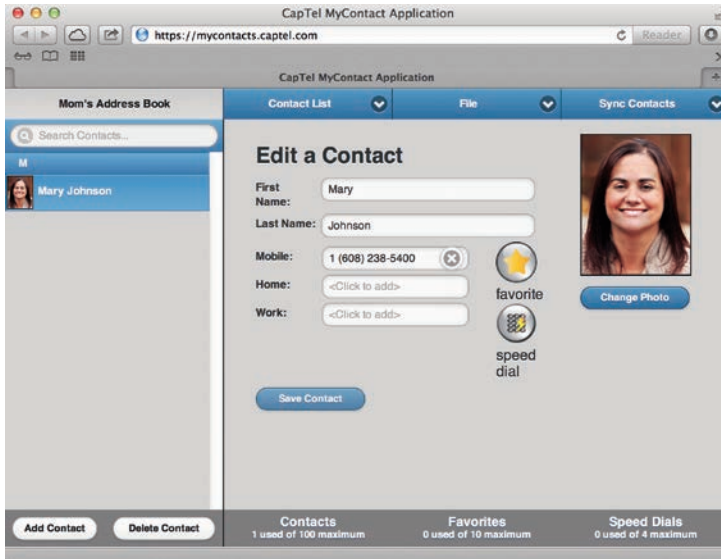

TIP *To resize your image, click and drag on the sidebar to make the image bigger or smaller. Click and drag the shaded box area to position it around your picture.*

When you have a photo selected and sized, click on **Save** (**Save**).





When you are finished entering information for this contact, click on  (**Save Contact**). The new entry appears in your Contact List on the left side of the MyContacts website (in alphabetical order by first name).

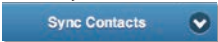

NOTE

Making your contact a Speed Dial number lets you quickly dial-by-picture on your CapTel phone. Click on  (**speed dial**) to add this contact to your Speed Dial list. You may have up to 4 Speed Dial entries. You can also add this number to your Favorites list for easy dialing. To add this contact to Favorites, click on  (**favorite**).

7. Repeat steps 4–6 to add as many contacts as you'd like – up to 100 entries total.

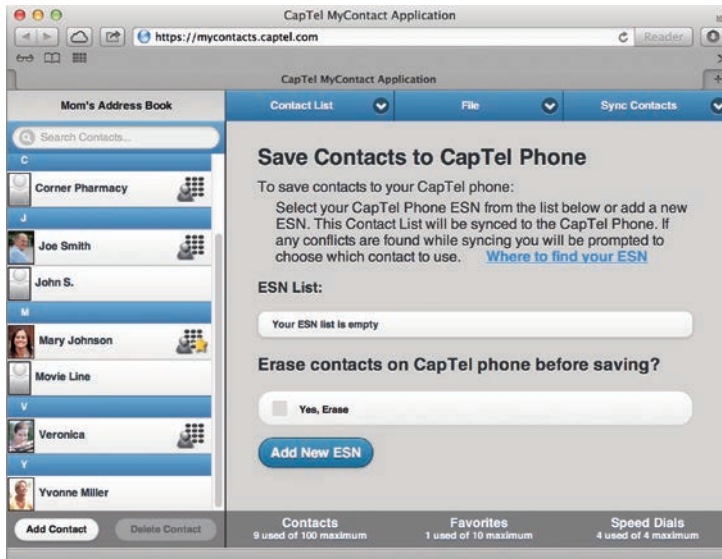
8. When you are satisfied with your Contact List, you must Sync Contacts in order to save the list to your CapTel phone. Click on  (**Sync Contacts**), then select  (**Save Contacts to Phone**).



9. The website asks you to select the Electronic Serial Number (ESN) for your CapTel phone. The ESN can be found **on your CapTel phone** by touching  (**Contacts**), then touching .

On your CapTel display screen:



At the MyContacts website:

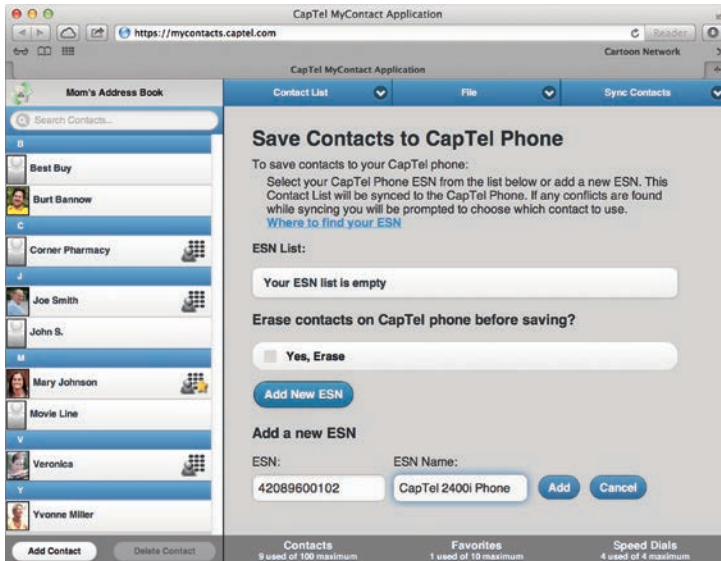

Click on **Add New ESN** (**Add new ESN**), then enter the ESN from the CapTel display screen into the field labeled “ESN”. Enter a name for the ESN in the field labeled “ESN Name”. Click on **Add** (**Add**).

On your CapTel display screen:



10. At the window on your CapTel phone that says, “sync your contacts?” touch **accept** (**Accept**).

At the MyContacts website:

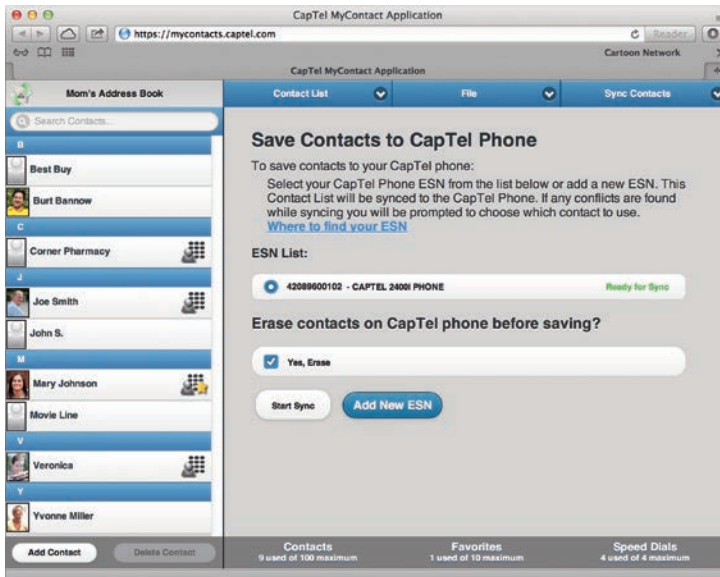

NOTE

Entries from your online Contact List are added to any contacts you may already have saved on your phone. If you would like to erase the existing contacts on your phone and replace them with the new Contact List from your computer, click on “Yes, Erase” on the MyContacts website before you start the sync process.

The website lets you know when the phone is ready to sync. Make sure the ESN you want is selected, then click on  **(Start Sync)** to begin the process.

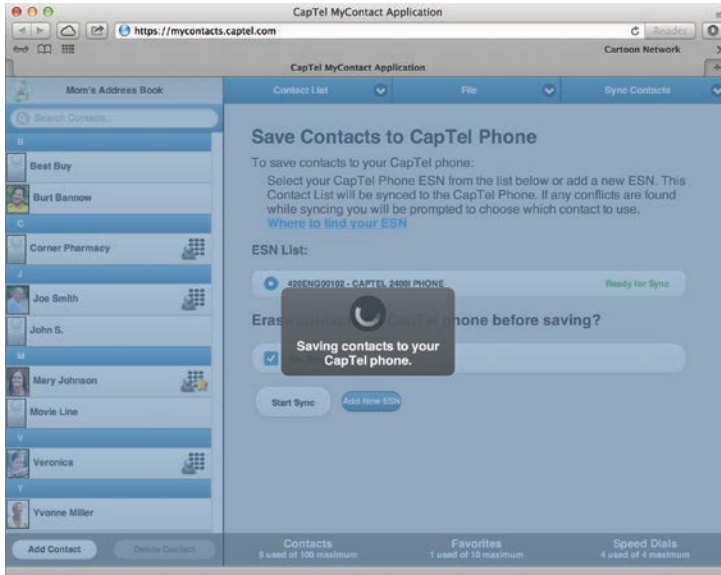

Your Contact List is saved from the computer onto your CapTel phone. Watch on your CapTel phone display as the sync completes.

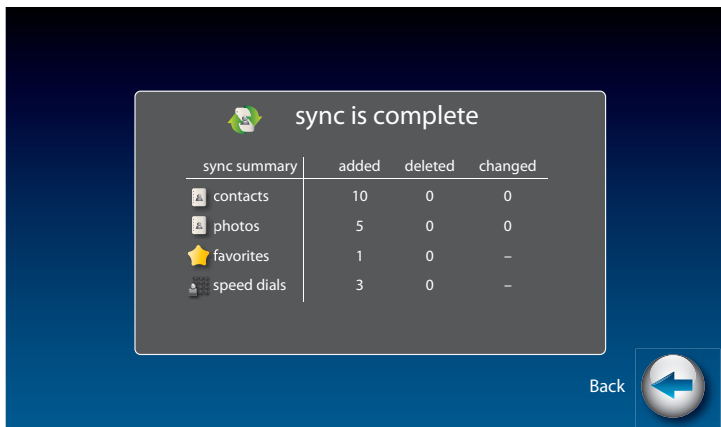

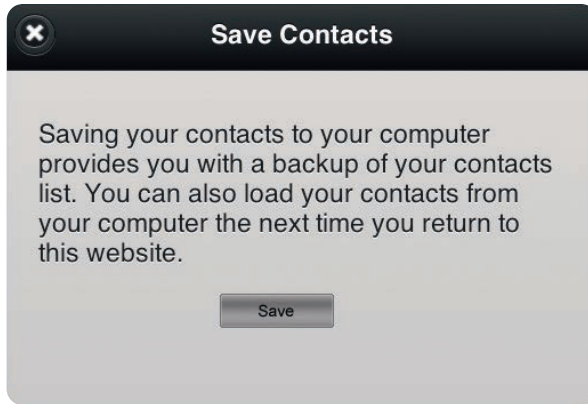

11. Once your Contact List is synced with your CapTel phone, you have the option to save your Contacts on your computer.

Saving a Contact List to your computer allows you to keep a back up and edit your list at a later time. You do not have to save your list on your computer – once the sync is finished, the Contact List is saved on your CapTel phone.

TIP *If you choose to save your Contact List, make note of where the xml file is saved on your computer for future reference.*

NOTE *Once the sync process is complete, your Contact List is saved on your CapTel phone. It will not change until you make changes on the phone or sync again with a different Contact List.*

12. Exit the MyContacts website by clicking on [Contact List](#) (**Contact List**), then selecting [Exit MyContacts](#) (**Exit MyContacts**).

Other options available at MyContacts.CapTel.com

Contact List

Under "Contact List"

Manage Favorites – Lets you add or delete contacts in your Favorites list. You can drag & drop any name from your Contact List on the left into your Favorites list.

Manage Speed Dials – Lets you add or delete contacts in your Speed Dial.

Manage ESN(s) – Lets you add or delete the Electronic Serial Number (ESN) of each CapTel phone.

Create a New Contact List – Lets you create a new Contact List. You can have multiple Contact Lists (i.e., one for business contacts, one for personal numbers, etc.).

Rename this Contact List – Lets you rename the current Contact List.

Exit MyContacts – To leave the MyContacts website. If any changes have been made, you can save the current Contact List to your computer. If you do not save, all information will be lost for security purposes. If the Contact List was already synced to your CapTel 2400i SPK, however, the information will already be saved on your phone.

File

Under "File"

Load Contacts from Computer – Opens any Contact Lists that you may have already saved on your computer, for you to edit or add new entries to.

Save Contacts to Computer – Lets you save a backup copy of the current Contact List to your computer. You can access the saved copy again at a later time to edit or add new entries.

Sync Contacts

Under "Sync Contacts"

Load Contacts from Phone – Brings the contacts you already have on your CapTel phone into the MyContacts website for you to edit or add photos to.

Save Contacts to Phone – Saves the current Contact List on the MyContacts website directly to your CapTel phone.

Favorites



This section tells you how to set your most frequently called Contacts as “favorites”, for quick dialing and dialing by photo.

TOPICS

- **About Favorites**
- **Adding a Contact to Favorites**
- **Dialing Favorites**
- **Removing a Contact from Favorites**

About Favorites



Favorites let you dial select numbers quickly and easily from the display screen. You can select any entries in your contact list to be included in your favorites list. You can save up to ten (10) phone numbers to your Favorites list.





NOTE

To add someone to your Favorites list, they must first be entered into your Contacts list. If you want to edit one of your Favorite's information, you must edit their entry in your Contacts list. See Adding a New Contact on page 73.

Adding a Contact to Favorites



You can save up to ten (10) numbers/entries to your Favorites list. To add a person from your Contact list to Favorites:



1. From the display screen, touch  (**Contacts**).
2. In the Contacts list on the left of the display, find and touch the name of the person you want to add to Favorites. To see contacts further down the list, touch and drag the scroll bar or touch  (**Next/Prev**) to move up/down through entries.
3. Touch  (**edit**).
4. Touch  (**favorite**).
5. If there are multiple phone numbers for this contact, the display asks which phone number (mobile, home, or work) you want to make a favorite. Touch the number(s) you want, then touch  (**Accept**). A little star appears by the appropriate phone number to indicate it is a favorite.

NOTE *If your Favorites list is full (10 entries), you need to remove a Favorite entry from the list first to make room in memory. See page 93 for instructions.*

6. Touch  (**save**).
7. When you are finished, press  (**HOME button**) to exit.

Dialing Favorites





To dial a person in your Favorites list:

1. From the display screen, touch  (**Favorites**).
2. Under the Favorites list on the left of display, find and touch the name of the person you wish to call.
3. On the right side of the display, touch  (**Call**). CapTel dials the phone number automatically.
4. Lift the handset to dial.

Removing a Contact from Favorites

You can remove a person from your Favorites list. Deleting a person from Favorites does NOT delete them from your Contacts list.

To delete a person in your Favorites list:

1. From the display screen, touch  (**Favorites**).
2. On the left side of the display, find and touch the name of the person you wish to delete.
3. Touch  (**Delete**).
4. CapTel asks you to confirm that you want to remove this contact from Favorites. Touch  (**yes**) to remove the Favorite or  (**no**) to exit.
5. When you are finished, press  (**HOME button**) to exit.

NOTE

Removing a person from your Favorites list does NOT remove them from your Contacts list.

Settings



This section explains how to adjust settings on your CapTel to fit your preferences.

TOPICS

- **Setting the Language**
- **Switching Captions Language During a Call**
- **Setting the Display Brightness**
- **Screen Timeout**
- **Night Mode**
- **Network**
- **Saving Captions After Hang up**
- **Captions Button**
- **Ring Flasher**
- **Saving Conversation Volume**
- **Keypad Lights**
- **Setting the Ringer Volume**
- **Adjusting the Ringer Pitch**
- **Tone Control**
- **Time & Date**
- **About Your CapTel Phone**
- **Updating Your Software**
- **Advanced Settings**

NOTE

Directions for some settings are found in other chapters of this user manual.

Setting the Language









Your CapTel phone can display captions in English or in Spanish. Whatever language you select, the Options menu will also appear in that same language. The default setting is English. Spanish captions must be turned on in the CapTel settings menu in order for you to receive Spanish-language captions.

NOTE

Spanish captioning is available for Spanish-to-Spanish conversations only. The CapTel 2400i does not translate from English conversations to Spanish conversations, and vice versa.

To set the language:

1. From the display screen, touch  (**Settings**).
2. Touch  (**General Settings**).
3. Touch  (**Language**).
4. Touch  for English-language captions or touch  for Spanish-language captions.
5. Touch  (**Back**) when you are finished.

NOTE

In some multi-lingual households, you may want to switch between English-language captions and Spanish-language captions during the same call. If you think that might apply to you, touch the check box to select "Able to switch languages during a call". If you anticipate your calls will only be in one language, either all in English or all in Spanish, do not check the box.

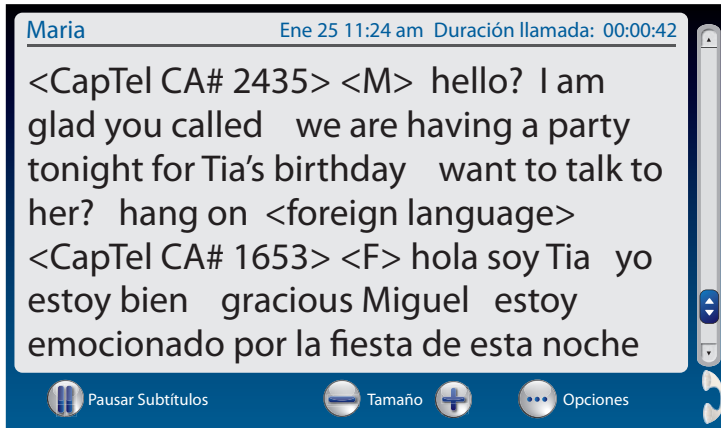

Spanish-to-Spanish captioning available everyday, 24/7.
For Spanish-language Customer Support: 1-866-670-9134

Switching Captions Language During a Call



NOTE *The Switch Language feature must be selected in order to change between languages during a call. The default setting is off. See page 95.*

To switch captions language during a call:

1. The call will begin in whichever language is selected in the Settings menu.
2. If you need to switch the captions language while the call is in progress, touch  (**Opciones**), then touch  (**flags**). There will be a brief pause while your CapTel phone re-connects to the captioning service. Then captions will appear in the alternative language.

The call will be recorded in Call History as one call, even if you switch languages during the conversation.

When your call is completed (handset hung up), the captions language will go back to whichever language is selected in the settings menu.



NOTE *When the Switch Language feature is selected, you can set a default language for each person in your Contacts list. If a call comes in from (or is placed to) that Contact, the captions will automatically appear in the appropriate language.*

Setting a Default Language for Contacts



When the Switch Language feature is selected, you can assign a default language for each person in your Contact list. When a call comes in from (or is placed to) that contact, captions appear in the appropriate language.

To set a default language for a contact:

1. Make sure the Switch Language feature is selected.
2. From the Contacts list, touch the contact you wish to change from the list on the left. The contact's information appears on the right.
3. Touch  (**Edit**).
4. Touch  (**Default Language**). The flag icon toggles between English and Spanish.
5. When you have the language you want, touch  (**save**).

Setting the Display Brightness

You can adjust the brightness of the display screen for easy reading in well-lit or dimly-lit areas. The display screen brightness changes as you move the setting so you can see what it will look like.

 **Settings** →  **Display** →  **Brightness**

Screen Timeout

As an energy-saving measure, your CapTel screen will start becoming more dim and gradually go complete dark after 60 seconds of non-use. Touching the display screen restores it to its original brightness. You can set how much time you want the screen to wait before becoming dim.

 **Settings** →  **Display** →  **Screen Timeout**



Night Mode

There may be times that you want your CapTel display to be at a darkened setting, called Night Mode. This is helpful, for example, in a bedroom at night when you don't need the bright display screen. You can set how long Night Mode stays on before the screen goes dark.

 **Settings** →  **Display** →  **Night Mode**

Network

If you use CapTel in a WiFi environment, the Network Setting shows you a list of all available WiFi networks within range, in order of the strongest signal strength to the weakest. You can change between WiFi networks or save common settings that you use most often.

 **Settings** →  **Network**

Saving Captions After Hang Up

You can set CapTel to save conversation captions after the call is over for later review, or to erase all captions each time the telephone is hung up. The default setting is Save Captions On.

 **Settings** →  **General Settings** →  **Save Captions On**

Captions Button

You can set the CAPTIONS button to automatically stay on or to automatically stay off at the beginning of every call. The default setting is Captions ON. If the CAPTIONS button is set to OFF, captions will not come on automatically. You must press the CAPTIONS button manually in order to turn captions on.

 **Settings** →  **General Settings** →  **Captions Button on**

Ring Flasher

CapTel includes a bright Ring Flasher that lights up to alert you every time a call comes in or whenever you have answering machine messages waiting. You can adjust the flash rate of the Ring Flasher for different indicators. For example, the Ring Flasher can blink evenly to indicate an answering machine message and can pulse to indicate an incoming call. To adjust the Ring Flash patterns:

 **Settings** →  **General Settings** →  **Flasher Settings**

Saving Conversation Volume

Your CapTel phone amplifies the voice of the caller up to 40dB. Every time you hang up the phone, the volume returns to a mid-range setting. You can set CapTel to remember the conversation volume setting so that it always stays at your desired volume level. The default setting is Save Volume Off.

 **Settings** →  **General Settings** →  **Save Volume**

Keypad Lights

The CapTel keypad lights up for easy dialing in dark environments. You can set the keypad lights to go off when your CapTel is not in use. When set to “off” the keypad lights will go off after approximately 30 seconds of non-use. The default setting is Keypad Lights On.

 **Settings** →  **General Settings** →  **Keypad Lights On**

Setting the Ringer Volume

You can turn the Ringer Volume up to a setting you hear best. The default setting is five (5). To turn the ringer off, select setting level zero (ringer muted).

 **Settings** →  **Sounds** →  **Ringer Volume**

Adjusting the Ringer Pitch

You can adjust the frequency of the CapTel ringer to a High, Medium, or Low range that you hear best. The default setting is Med.

 **Settings** →  **Sounds** →  **Ringer Pitch**

Tone Control

You can adjust the frequency of the sound coming through the CapTel handset to a frequency range that you hear best. Select from Low, Medium, High, or Customizable Frequency Ranges. To customize the frequency range, see page 33 for instructions.

 **Settings** →  **Sounds** →  **Tone**

Time Zone

You can adjust the time and date displayed on your CapTel phone screen based on your Time Zone. Touch the area on the map for the Time Zone that you live in. Be sure to indicate if your Time Zone practices Daylight Savings Time (DST).

 **Settings** →  **Time and Date**

About Your CapTel Phone

Provides details about how your CapTel phone is set up to help with troubleshooting issues.

 **Settings** →  **Info**

Updating Your Software

You can download the most current version of CapTel software to your phone. Once the download is complete, your CapTel phone will re-boot as part of the update process. Software downloads are encrypted for optimal security.

 **Settings** →  **Info** →  **Update**

Advanced Settings

Dialing Prefix

Some office environments require you to dial a number in order to get an outside line. For example, you may need to dial a 9 or another number sequence before you can place a call. CapTel lets you add a dialing prefix, then will dial it for you automatically for every call placed from your Contact list, or when using the Speed Dial, Call History, or Answering Machine history. If you dial the phone number directly, you will need to enter the Dialing Prefix at the time you dial. The default setting is no dialing prefix.

 **Settings** →  **General Settings** →  **Advanced Settings**
→  **Dialing Prefix.**

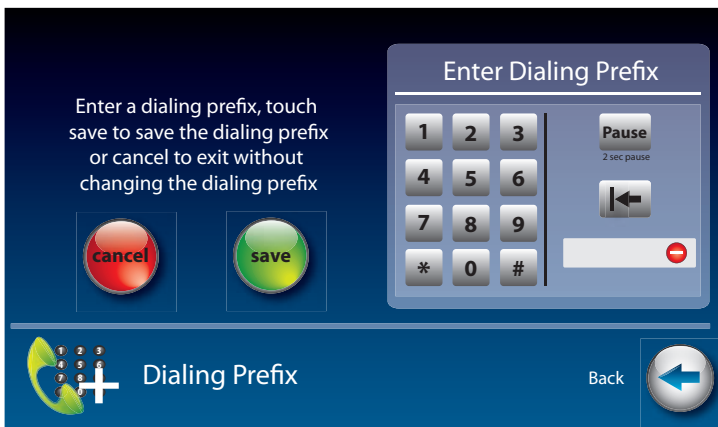

Dynamic or Static IP

Using a Dynamic IP address (DHCP) is recommended to avoid IP conflicts. Some networks do not allow DHCP. In those cases, a Static IP address may be used. The default setting is Dynamic IP.

 **Settings** →  **General Settings** →  **Advanced Settings**
→  **Dynamic or Static IP**

Review Captions on Hang Up

You can set your CapTel phone to automatically go to conversation review mode after you hang up. This allows you to review the previous conversation(s) immediately after every call without using the Menu system. The default setting is off.

 **Settings** →  **General Settings** →  **Advanced Settings**
→  **Review Captions on Hang Up**

Line in Use Detector

CapTel can help detect when another telephone in your home or office is off-hook (for example, if someone is talking on another telephone in your home that is connected to same line or if another telephone on that line is not hung up). This can be helpful if multiple people/devices share your telephone line.

When Line in Use is on: you can join a call in progress that has been answered on an extension line by simply picking up the CapTel handset and you will get captions. The default setting is on.

When Line in Use is off: If the call was answered on an extension line, you can join by picking up the CapTel handset and pressing one of the keys on the number keypad. The captioning service will connect to the call and you will get captions.

 **Settings** →  **General Settings** →  **Advanced Settings**
→  **Line in Use Detector**

Voice Activity Detector

The built-in answering machine allows one minute for your callers to leave a message. In some cases, your callers' messages may be shorter than one minute. You can set the answering machine to hang up the telephone line once the incoming caller stops talking (stops leaving their message) instead of waiting the full one minute. The default setting is off.

 **Settings** →  **General Settings** →  **Advanced Settings**
→  **Voice Activity Detector**

Troubleshooting

Power Reset

On occasion, issues with your Internet connection may impact your CapTel phone. For example, you may have experienced times when your Internet seems to get “hung up” or things don’t look correct on your computer screen. These cases can sometimes impact how your CapTel phone operates. To correct, you may need to “reset” your CapTel phone, the same way you might “reset” your computer.



To Reset: Briefly unplug CapTel phone from the power adapter, wait 10 seconds, then plug it back in. The display screen lights up while the phone powers up. Then the display automatically takes you through the set-up steps again, asks you to confirm your language choice, checks your Internet connection, and confirms your time/date zone. CapTel will also check to make sure you have the most current software, and download any updates as needed.

Using Flash Option



Some telephone services like Call Waiting require a “hook flash”. The hook flash is a very brief interruption of the connection, like hanging up the phone for one second. There is a brief click or silence on the line. If you are on a call and see [beep] in the captions, you may have another call coming in. Touch the Options icon on the screen, then touch the FLASH icon once to pick up the incoming call (the current call goes on hold). Touch Options then the FLASH icon again to return to the original call.

To use Flash option during a call:

1. On the display screen, touch  (**Options**).
2. Touch  (**Flash**).
3. Touch  (**Back**) when you are finished.

CAPTEL 2400i SP-NBT INDEX

Answering a call.....	25	Captions.....	4, 9, 34–44, 52, 99
on an extension phone	25	button.....	6, 9, 99
with captions	25	change font color	41–42
Answering Machine.....	51	change font size and style.....	43
erase messages	54, 55, 56	erase	40
play messages	54	how captions scroll.....	44
play messages aloud/silent	64	In Spanish.....	12, 95, 96
record personal greeting.....	57	preference, method of captioning...	21
remote message retrieval.....	59	review after a call.....	38
see captions.....	52, 54, 64	review captions of previous call.....	48
set number of rings	63	review during a call.....	37
turn on/off.....	53	save captions after hanging up.....	39
voicemail	65–70, 71	switching captions method.....	26
Buttons	8, 9	turn on/off.....	35
captions	6, 9	Contacts.....	72
customer service.....	6, 9	add new	73
dialing keypad	6, 8	add picture to contact.....	77, 78–88
home.....	6, 8	dial from.....	74
mute.....	6, 9	editing	75
speaker.....	6, 8, 30–31	erase a contact	76
volume	6, 8	Conversation Memory.....	39
Calls	22	Corrections	36
make/answer calls.....	22–27	Customer Service button	6, 9
use Call History.....	49	calling for help.....	back cover
Call History.....	46	Spanish customer	
delete.....	50	service.....	95, back cover
dial from.....	49	Dialing	23
review calls	47	by picture	77, 78–88
review captions from call	48	dialing 9 in an office setting	102
Call waiting	104	from Call History	49
		from Contact list	74
		from Favorites.....	93
		from number keypad	23
		with Speed Dial	77

Display Screen	6, 44	Personal identification	
adjust brightness.....	45, 98	number (PIN).....	59–60, 61
night mode.....	98	Power Reset.....	104
screen timeout	45, 98	Reading captions.....	34
Flash option (hook flash)	104	after hang up	38
Flasher	99	during a call	37
set the ring flasher	99	from previous call.....	48
Indicator Lights	8	Redial	24
on keypad	100	Remote Message Retrieval.....	59
mute.....	9	accessing message remotely	61
ring flasher	99	personal identification	
volume	8, 27	number PIN	59–60, 61
Internet	11, 13–17	remote access commands	60, 61
connecting to the Internet.....	13	turning on/off	59
requirements	11	Reset.....	104
using a router.....	13, 14	Ringer	100
using WiFi.....	15	adjust pitch.....	100
Keypad	6, 8	adjust volume.....	100
dialing from	23	ring flasher.....	7, 99
lights	100	turn ringer off	100
Language	12, 95–97	Ring flasher	7, 99
English.....	12, 95–97	Scroll, captions across display	44
Spanish.....	12, 95–97	smooth scrolling	44
Messages, Answering Machine	51	word-by-word scrolling	44
erase messages	54, 55, 56	Settings	94–103
from an External Ans Machine.....	62	Setup.....	11
play aloud/silent	64	help with set up	back cover
play messages	54	requirements	11
Mute button	6, 9	using a router.....	13, 14
Network	13	using wireless/WiFi	15–17
available networks.....	16, 98		
change settings.....	16, 98		
view saved networks.....	98		
WiFi.....	15		

Sound	28, 29	Troubleshooting.....	104
adjusting on the speakerphone.....	27	Updating your software	101
adjusting the sound quality	28, 29		
Spanish.....	12, 95, 96, 97	Voicemail.....	65
captions	12, 95, 96, 97	calling your Voicemail service	71
customer service		listening to messages	67
in Spanish.....	95, back cover	tips	68
Speaker button	6, 8, 36–37	turning Indicator off.....	68
Speakerphone	30	turning Indicator on	66
ending a call	31	troubleshooting.....	69
turning on/off.....	30	Volume.....	8
Speed dial	77	adjust during a call.....	27
adding contact to.....	77	button.....	6, 8
adding picture to.....	78	Ringer volume	100
dialing from	77	save conversation volume	100
Time Zone	17, 101	WiFi/Wireless network.....	15–17
Tone Control	28, 29, 101	enter network manually.....	16
customize Tone setting.....	29	view networks	15–16, 98

FCC Information

The CapTel has been tested and found to comply with the specifications for a Class B digital device pursuant to Part 15 of the FCC Rules. These limits are designed to provide reasonable protection against harmful interference in a residential installation. This equipment generates and uses radio frequency energy and if not installed and used in accordance with the instructions, may cause harmful interference to radio communications. However, there is no guarantee that interference will not occur in a particular installation.

If this equipment does cause harmful interference to radio or television reception, which can be determined by turning the equipment off and on, the user is encouraged to try to correct the interference by one or more of the following measures:

- Reorient or relocate the receiving antenna.
- Increase the separation between the CapTel and the receiver.
- Connect the CapTel to an outlet on a circuit different from that to which the receiver is connected.
- Consult the dealer or an experienced radio/TV technician for help.

This equipment complies with Part 68 of the FCC rules and the requirements adopted by the ACTA. A label is located on the underside of the CapTel containing, among other information, an ACTA Product-Labeling Number, US:D8KTE00BCAP2400. If requested, this number must be provided to the telephone company.

A plug and jack used to connect this equipment to the premises wiring and telephone network must comply with the applicable FCC Part 68 rules and requirements adopted by the ACTA. A compliant telephone cord and modular plug is provided with this product. It is designed to be connected to a compatible modular jack that is also compliant. See installation instructions for details.

The REN is used to determine the quantity of devices which may be connected to the telephone line. Excessive RENs on the line may result in the devices not ringing in response to an incoming call. In most, but not all, areas the sum of RENs should not exceed five (5.0). To be certain of the

number of devices that may be connected to a line, as determined by the total RENs, contact the local telephone company. The REN for this product is 0.0B.

Should you experience trouble with this telephone equipment, please contact:

CapTel Customer Service
450 Science Drive
Madison, WI 53711
Phone: 888-269-7477 V/TTY
Email: CapTel@CapTel.com

For repair or warranty information, please contact CapTel Customer Service at 1-888-269-7477 (V/TTY). If the equipment is causing harm to the telephone network, the telephone company may request that you disconnect the equipment until the problem is resolved.

This equipment cannot be used on public coin phone service provided by the telephone company. Connection to party line service is subject to state tariffs.

If the CapTel causes harm to the telephone network, the telephone company will notify you in advance that temporary discontinuance of service may be required. But, if advance notice is not practical, the telephone company will notify you as soon as possible. Also, you will be advised of your right to file a complaint with the FCC if you believe it is necessary.

Occasionally, your telephone company may make changes in its facilities, equipment, operation, or procedures that could affect the operation of your equipment. If so, you will be given advance notice of the change to give you an opportunity to maintain uninterrupted service.

If your home has specially wired alarm equipment connected to the telephone line, ensure the installation of the CapTel does not disable it. If you have questions about what will disable alarm equipment, consult your telephone company or a qualified installer.

The CapTel telephone does not have any user-serviceable parts. Modification or changes to the CapTel not expressly approved by Ultratec, Inc. can void your authority to operate the equipment.

Compliance Statement (Part 15.19)

This device complies with Part 15 of the FCC Rules.

Operation is subject to the following two conditions:

1. This device may not cause harmful interference, and
2. This device must accept any interference received, including interference that may cause undesired operation.

Warning (Part 15.21)

Changes or modification not expressly approved by the party responsible for compliance could void the user's authority to operate the equipment.

FCC Interference Statement (Part 15.105b)

This equipment has been tested and found to comply with the limits for a Class B digital device, pursuant to Part 15B of the FCC Rules. These limits are designed to provide reasonable protection against harmful interference in a residential installation. This equipment generates uses and can radiate radio frequency energy and, if not installed and used in accordance with the instructions, may cause harmful interference to radio communications. However, there is no guarantee that interference will not occur in a particular installation. If this equipment does cause harmful interference to radio or television reception, which can be determined by turning the equipment off and on, the user is encouraged to try to correct the interference by one of the following measures:

- Reorient or relocate the receiving antenna.
- Increase the separation between the equipment and receiver.
- Connect the equipment to an outlet on a circuit different from that to which the receiver is connected.
- Consult the dealer or an experienced radio/TV technician for help.

RF Exposure (OET Bulletin 65)

To comply with FCC/IC exposure requirements for mobile transmitting devices, this transmitter should only be used or installed at location where there is at least 20 cm separation distance between the antenna and all persons.

To comply with FCC/IC RF exposure limits for general population/uncontrolled exposure, the antenna(s) used for this transmitter must be installed to provide a separation distance of at least 20 cm from all persons and must not be co-located or operating in conjunction with any other antenna or transmitter.



Privacy Policy

A copy of the CapTel Privacy Policy is available for you to review online at www.CapTel.com/Privacy or you can request a printed copy by calling 1-877-464-9149.

FEDERAL LAW PROHIBITS ANYONE BUT REGISTERED USERS WITH HEARING LOSS FROM USING INTERNET PROTOCOL (IP) CAPTIONED TELEPHONES WITH THE CAPTIONS TURNED ON. Advanced speech recognition software is used to process calls, and, in certain circumstances, a live communications assistant may be included on the call. There is a cost for each minute of captions generated, paid from a federally administered fund. No cost is passed on to the CapTel user for using the service.

Getting Help

If you have any questions as you use your new CapTel 2400i, we're here to help. Use any of these ways to contact us:

Pick up the handset and press  (**CUSTOMER SERVICE button**) to automatically speed dial directly to our helpful Customer Service team. If you are in an office setting, you may need to dial a number such as "9" first to get an outside line first and then press  (**CUSTOMER SERVICE button**). *(Available 24 hours a day, 7 days a week. Customer Service is closed on major holidays.)*

Help materials are also available online at our website.



Phone: 1-888-269-7477 *(Available 24 hours a day, 7 days a week)*

FAX: (608) 204-6167



Mail: CapTel Customer Service
450 Science Drive
Madison, WI 53711



Email: CapTel@CapTel.com

Online: www.CapTel.com
(Live Chat help available at our website)

Spanish Language Customer Service: 1-866-670-9134

CapTel is the latest innovation from  **Ultratec**.

Ultratec, Inc.

450 Science Drive

Madison, WI 53711

(888) 269-7477 V/TTY

(866) 670-9134 (Spanish CapTel Customer Service)

Email: CapTel@CapTel.com • Fax: (608) 204-6167 • Web: www.CapTel.com

©2016-2023 Ultratec, Inc. All rights reserved.

Ultratec and CapTel are registered trademarks of Ultratec, Inc.

Other trademarks and trade names are property of their respective owners.